

DK-LOK









Fittings & Valves

DK Seal-Lok Tube Fittings







No.01-9
July 2017





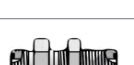



Nuts, Sleeves Locknuts





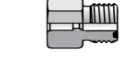

Tube Nut HDN		3
Tube Nut – mm Hex HDN		3
Parflange Sleeve HDPS (Metric)		3
Parflange Sleeve HDPS (Inch)		3
Braze Reducer Sleeve HDS (Inch)		4
Braze Reducer Sleeve HDS (Metric)		4
Braze Ring HDBR (Inch and Metric)		5
Bulkhead Locknut HDBN		5
Bulkhead Locknut – mm Hex HDBN		5

Straights

Union HDU		6
Union – mm Hex HDU		6
Bulkhead Union HDUB		6
Bulkhead Union – mm Hex HDUB		7
ORFS Bulkhead / SAE-ORB HDUBMC-U		7
ORFS / SAE-ORB HDMC-U		8
ORFS – Long / SAE-ORB HDMCL-U		98

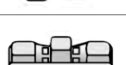

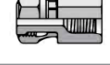

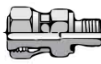
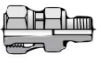

ORFS / NPTF HDMC-N		8
ORFS / NPTF HDCF-N		9
ORFS / ISO 6149 HDMC-M		9
ORFS / Metric-ED HDMC-MED		9
ORFS / BSPP-ED HDMC-GED		9
ORFS / Braze Socket HDCF-TSW		10
ORFS / Braze - mm Hex HDCF-MSW		10
ORFS / Tube Weld HDCW		10

Straights Swivels







Tube End Reducer HDSV		11
Extender and Expander HDMCSV		11
ORFS Swivel Union HDSVU		11
ORFS Swivel / SAE-ORB HDSVMC-U		12
ORFS Swivel / SAE-ORB HDSVCF-U		12
ORFS Swivel / NPTF HDSVMC-N		12
ORFS Swivel / NPTF HDSVCF-N		12
ORFS Swivel / ISO 6149 HDSVMC-M		13





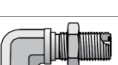





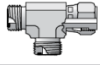

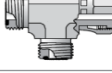

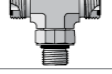

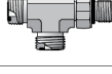



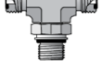

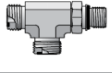

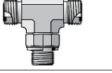
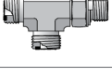

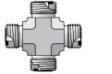
ORFSSwivel / Metric-ED HDSVMC-MED		13
ORFSSwivel / BSPP-ED HDSVMC-GED		13

45° Elbows

Bulkhead Union HDLBUB		13
Bulkhead Union – mm Hex HDLBUB		14
ORFS Swivel Elbow HDLB-SV		14
ORFS / SAE -ORB HDLB-UP		14
ORFS / ISO 6149 HDLB-MP		14
ORFS / NPTF HDLB-N		15
ORFS / BSPP-ORR HDLB-GP		15

90° Elbows

Union Elbow HDL		15
Union Elbow – mm Hex HDL-M		15
Bulkhead Union HDLUB		16
Bulkhead Union – mm Hex HDLUB-M		16
ORFS Swivel Elbow HDL-SV		17
Swivel Elbow – mm Hex HDL-SV		17

ORFS Swivel / SAE - ORB		17	ORFS Swivel Run		23
HDSVL			HDTRSV		
ORFS Swivel / SAE - ORB		17	Swivel Run – mm Hex		23
HDL-UP			HDTRSV		
ORFS Swivel / SAE - ORB		18	SAE – ORB Branch Tee		23
HDLL			HDTBM-UP		
ORFS / NPTF		18	SAE – ORB Run Tee		24
HDL-N			HDTRM-UP		
ORFS / NPTF		18	NPTF Branch Tee		24
HDL-MPK			HDTBM		
ORFS / ISO 6149 - Long		19	ISO 6149 Branch Tee		24
HDLL-MPK			HDTBM-MP		
ORFS / Metric - ORR		19	ISO 6149 Run Tee		25
HDL-MP			HDTRM-MP		
ORFS / BSPP - ORR		20	BSPP – ORR Branch Tee		25
HDL-GP			HDTBM-GP		
Tees			BSPP – ORR Run Tee		26
Union Tee		20	HDTRM-GP		
HDT			Crosses		
Union Tee – mm Hex		20	Union Cross		26
HDT			HDX		
Bulkhead Branch		20	Plugs, Caps and Bleed Adapters		
HDTBM			ORFS Plug		27
Bulkhead Branch – mm Hex		21	HDP		
HDTBM			ORFS Plug – mm Hex		27
Bulkhead Run		21	HDP		
HDTRM			ORFS Cap		27
Bulkhead Run – mm Hex		22	HDC		
HDTRM			ORFS Cap – mm Hex		27
ORFS Swivel Branch		22	HDC		
HDTBSV					
ORFS Swivel Branch – mm Hex		22			
HDTBSV					

UPTC Nut Assembly
Nut Assembly  28

HDUPTC

HDN

Tube Nut
ORFS

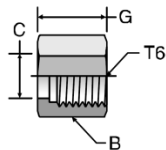

SAE 520110

TUBE FITTING PART #	END SIZE (in.)	T6 UNF/UNF-2 B	B HEX (in.)	C (mm)	G (mm)
HDN-4T	1/4	9/16 - 18	11/16	10.41	14.99
HDN-5T	5/16	5/8 - 18	3/4	11.94	16.00
HDN-6T	3/8	11/16 - 16	13/16	13.46	17.02
HDN-8T	1/2	13/16 - 16	15/16	16.51	20.07
HDN-10T	5/8	1 - 14	1 1/8	21.08	23.88
HDN-12T	3/4	1 3/16 - 12	1 3/8	24.13	26.42
HDN12T-14T	7/8	1 3/16 - 12	1 3/8	25.15	30.48
HDN-14T	7/8	1 5/16 - 12	1 1/2	27.31	26.42
HDN-16T	1	1 7/16 - 12	1 5/8	29.21	27.43
HDN-20T	1 1/4	1 11/16 - 12	1 7/8	36.07	27.43
HDN-24T	1 1/2	2 - 12	2 1/4	43.94	27.43
HDN-32T	2	2 1/2 - 12	2 7/8	56.39	33.02

*Sizes 14 and 32 are not included in SAE J1453.

** These tube nuts should not be exposed to annealing temperatures, Such as furnace brazing. Contact the Tube Fittings Division for Information on special nuts.

• Stainless steel tube nuts are prelubricated for ease of assembly.

HDN

Tube Nut – mm Hex
ORFS

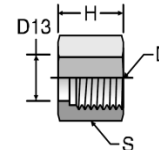

ISO 8434-3 NA
SAE 52M0110A

TUBE FITTING PART #	END SIZE		D THREAD UN/UNF - 2B	D13 DRILL (mm)	H (mm)	S HEX (mm)
	(mm)	(in.)				
HDN-6M	6	1/4	9/16 - 18	10.50	15.0	17
HDN-8M10M	8,10	3/8	11/16 - 16	13.55	17.5	22
HDN-12M	12	1/2	13/16 - 16	16.60	20.0	24
HDN-14M15M16M	14,15,16	5/8	1 - 14	21.10	24.0	30
HDN-18M20M	18,20	3/4	1 3/16 - 12	24.15	26.5	36
HDN-22M25M	22,25	1	17/16 - 12	29.10	27.5	41
HDN-28M30M32M	28,30,32	1 1/4	1 11/16 - 12	36.00	27.5	50
HDN-35M38M	35,38	1 1/2	2 - 12	44.00	27.5	60

HDPS (Metric)

Parflange Sleeve for
Metric Tubing
ORFS Mechanically
Attachable Sleeve

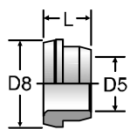

TUBE FITTING PART #	USED WITH FITTING SIZE	D5 END SIZE (mm)	D8 DIA (mm)	L (mm)
HDPS-6M	-4	6	12.75	7.5
HDPS-8M	-6	8	15.75	8.5
HDPS-10M	-6	10	15.75	8.5
HDPS-12M	-8	12	18.90	10.5
HDPS-14M	-10	14	23.50	10.5
HDPS-15M	-10	15	23.50	10.5
HDPS-16M	-10	16	23.50	10.5
HDPS-18M	-12	18	27.80	12.0
HDPS-20M	-12	20	27.80	12.0
HDPS-25M	-16	25	34.00	13.5
HDPS-30M	-20	30	40.50	13.0
HDPS-32M	-20	32	40.50	13.0
HDPS-35M	-24	35	48.50	12.5
HDPS-38M	-24	38	48.50	12.5

*Must be mechanically attached using Parflange system.

*Additional-S not required, TPLS6 is complete part number.

HDPS (Inch)

Parflange Sleeve
for Inch Tubing
ORFS Mechanically
Attachable Sleeve

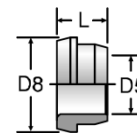

TUBE FITTING PART #	D5 END SIZE (in)	D8 DIA (mm)	L (mm)
HDPS-4T	1/4	12.70	7.62
HDPS-6T	3/8	15.75	8.64
HDPS-8T	1/2	18.80	10.67
HDPS-10T	5/8	23.37	10.67
HDPS-12T	3/4	27.69	11.94
HDPS-16T	1	34.04	13.46
HDPS-20T	1 1/4	40.39	12.95
HDPS-24T	1 1/2	48.51	12.45
HDPS-32T	2	60.71	13.72

*Must be mechanically attached using Parflange system.

HDS (Inch)

Brase Sleeve for Inch Tubing
ORFS Silver Braze Sleeve Reducer

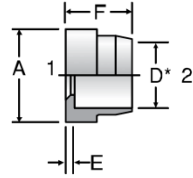

SAE 520115

TUBE FITTING PART #	END SIZE		A (mm)	D* (mm)	E (mm)	F (mm)
	1 (in.)	2 (in.)				
HDS-4T	1/4		12.70	6.60	1.02	9.40
HDS-6T	3/8		15.75	9.65	1.02	9.40
HDS6T-4T	3/8	1/4	15.75	6.60	2.03	10.41
HDS-8T	1/2		19.05	12.95	1.02	9.40
HDS8T-4T	1/2	1/4	19.05	6.60	3.56	11.94
HDS8T-6T	1/2	3/8	19.05	9.65	3.56	11.94
HDS-10T	5/8		23.37	16.00	1.52	10.41
HDS10T-4T	5/8	1/4	23.37	6.60	5.08	13.46
HDS10T-6T	5/8	3/8	23.37	9.65	5.08	13.46
HDS10T-8T	5/8	1/2	23.37	12.95	5.08	13.46
HDS-12T	3/4		27.94	19.30	1.52	13.97
HDS12T-4T	3/4	1/4	27.94	6.60	6.10	14.48
HDS12T-6T	3/4	3/8	27.94	9.65	6.10	14.48
HDS12T-8T	3/4	1/2	27.94	12.95	6.10	14.48
HDS12T-10T	3/4	5/8	27.94	16.00	5.59	14.48
HDS12T-14T	3/4	7/8	27.94	22.35	1.52	16.51
HDS-14T	7/8		30.99	22.35	1.52	13.97
HDS-16T	1		34.29	25.65	1.52	15.49
HDS16T-8T	1	1/2	34.29	12.95	7.11	15.49
HDS16T-10T	1	5/8	34.29	16.00	6.60	15.49
HDS16T-12T	1	3/4	34.29	19.30	4.57	17.02
HDS16T-14T	1	7/8	34.29	22.35	4.57	17.02
HDS-20T	1 1/4		40.64	32.00	1.52	15.49
HDS20T-12T	1 1/4	3/4	40.64	19.30	7.11	19.56
HDS20T-16T	1 1/4	1	40.64	25.65	7.11	21.08
HDS-24T	1 1/2		48.51	38.35	1.52	15.49
HDS24T-16T	1 1/2	1	48.51	25.65	7.11	21.08
HDS24T-20T	1 1/2	1 1/4	48.51	32.00	7.11	21.08
HDS-32T	2		61.21	51.05	1.52	16.51

Unplated part, oil dipped for corrosion protection.

*D is for silver brazing.

** 12-14 TL must be assembled with 12-14 BL.

***Size 14 and 32 are not included in SAE J1453.

•Uses SBR silver braze rings.

HDS (Metric)

Brase Sleeve for Metric Tubing
ORFS Silver Braze Sleeve

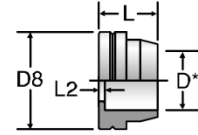

ISO 8434-3 BRSL
SAE 5201M15

TUBE FITTING PART #	USED WITH FITTING SIZE	D* END SIZE (mm)	D8 DIA (mm)	L (mm)	L2 (mm)
HDS-6M	-4	6	12.8	9.5	1.0
HDS-8M	-6	8	15.8	9.5	1.0
HDS-10M	-6	10	15.8	9.5	1.0
HDS-12M	-8	12	18.9	9.5	1.0
HDS-16M	-10	16	23.5	10.5	1.5
HDS-20M	-12	20	27.9	14.0	1.5
HDS-25M	-16	25	34.2	15.5	1.5
HDS-30M	-20	30	40.6	15.5	1.5
HDS-38M	-24	38	48.5	15.5	1.5

Unplated part, oil dipped for corrosion protection.

*D is for silver brazing.

•Uses SBR (metric) silver braze rings.

•Stainless steel part number example: TLSS10.

HDBR (Inch)

Silver Braze Ring for Inch Tubing

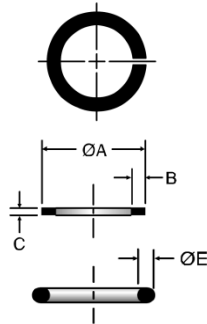

TUBE FITTING PART #	END SIZE (in.)	A DIA (mm)	B (mm)	C (mm)	E (mm)
HDBR-4T	1/4	6.60	-	-	1.27
HDBR-6T	3/8	9.91	1.78	0.76	-
HDBR-8T	1/2	13.08	1.78	0.76	-
HDBR-10T	5/8	16.26	1.78	0.76	-
HDBR-12T	3/4	19.43	2.03	1.02	-
HDBR-14T	7/8	22.61	-	-	1.52
HDBR-16T	1	25.78	2.03	1.02	-
HDBR-20T	1 1/4	32.13	2.03	1.02	-
HDBR-24T	1 1/2	38.48	2.03	1.02	-
HDBR-32T	2	51.18	-	-	2.29

SBR recommended for steel or copper tubing. -S not required.
SBR-SS recommended for stainless tubing. But can be used on steel tubing.
Contact the Tube Fittings Division for braze rings used in marine or special applications.

HDBR (Metric)

Silver Braze Ring for Metric Tubing

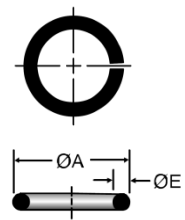

TUBE FITTING PART #	END SIZE (mm)	A DIA (mm)	E (mm)
HDBR-6M	6	6.4	1.2
HDBR-8M	8	8.4	1.2
HDBR-10M	10	10.4	1.2
HDBR-12M	12	12.4	1.2
HDBR-16M	16	16.4	1.2
HDBR-20M	20	20.4	1.6
HDBR-25M	25	25.4	1.6
HDBR-30M	30	30.4	1.6
HDBR-38M	38	38.4	1.6

SBR recommended for steel or copper tubing.
SBR-SS recommended for stainless tubing, but can be used on steel tubing.
Contact the Tube Fittings Division for braze rings used in marine or special applications.

HDBN

Bulkhead Locknut

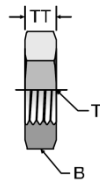

SAE 520118

TUBE FITTING PART #	END SIZE (in.)	T TUBE END UN/UNF - 2A	B HEX (in.)	TT (mm)
HDBN-4T	1/4	9/16 - 18	13/16	6.86
HDBN-6T	3/8	11/16 - 16	1	7.87
HDBN-8T	1/2	13/16 - 16	1 1/8	8.89
HDBN-10T	5/8	1 - 14	1 5/16	10.41
HDBN-12T	3/4	1 3/16 - 12	1 1/2	10.41
HDBN-14T	7/8	1 5/16 - 12	1 5/8	10.41
HDBN-16T	1	1 7/16 - 12	1 3/4	10.41
HDBN-20T	1 1/4	1 11/16 - 12	2	10.41
HDBN-24T	1 1/2	2 - 12	2 3/8	10.41

* Size 14 is not included in SAE J1453.

HDBN

Bulkhead Locknut – mm Hex

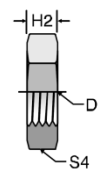

ISO 8434-3 BHLN
SAE 52M0118

TUBE FITTING PART #	END SIZE		D TUBE END UN/UNF - 2B	H2 (mm)	S4 HEX (mm)
	(mm)	(in.)			
HDBN-6M	6	1/4	9/16 - 18	7.0	22
HDBN-8M10M	8,10	3/8	11/16 - 16	8.0	27
HDBN-12M	12	1/2	13/16 - 16	9.0	30
HDBN-14M15M16M	14,15,16	5/8	1 - 14	10.5	36
HDBN-18M20M	18,20	3/4	1 3/16 - 12	10.5	41
HDBN-22M25M	22,25	1	1 7/16 - 12	10.5	46
HDBN-28M30M32M	28,30,32	1 1/4	1 11/16 - 12	10.5	50
HDBN-35M38M	35,38	1 1/2	2 - 12	10.5	60

HDU

Union
ORFS / ORFS

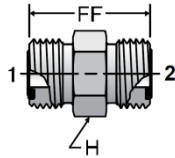

SAE 520101

TUBE FITTING PART #	END SIZE		FF (mm)	H HEX (mm)	Dynamic Pressure (x 1,000 PSI)
	1 (in.)	2 (in.)			
HDU-4T	1/4	1/4	27.43	5/8	9,200
HDU-6T	3/8	3/8	30.99	3/4	9,200
HDU6T-4T	3/8	1/4	29.97	3/4	9,200
HDU-8T	1/2	1/2	35.56	7/8	9,200
HDU8T-6T	1/2	3/8	33.53	7/8	9,200
HDU-10T	5/8	5/8	42.42	1 1/16	6,000
HDU10T-8T	5/8	1/2	39.88	1 1/16	6,000
HDU-12T	3/4	3/4	46.99	1 1/4	6,000
HDU12T-8T	3/4	1/2	42.93	1 1/4	6,000
HDU12T-10T	3/4	5/8	45.47	1 1/4	6,000
HDU-16T	1	1	49.53	1 1/2	6,000
HDU16T-12T	1	3/4	49.02	1 1/2	6,000
HDU-20T	1 1/4	1 1/4	51.56	1 3/4	6,000
HDU20T-16T	1 1/4	1	51.56	1 3/4	6,000
HDU-24T	1 1/2	1 1/2	53.09	2 1/8	5,000
HDU-32T	2	2	62.99	2 3/4	3,000

* Size 32 is not included in SAE J1453.

HDU

Union – mm Hex
ORFS / ORFS

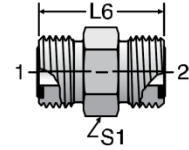

ISO 8434-3 S SAE 52M0101

TUBE FITTING PART #	END SIZE 1 & 2		L6 (mm)	S1 HEX (mm)	Dynamic Pressure (x 1,000 PSI)
	(mm)	(in.)			
HDU-6M	6	1/4	27.5	17	9,200
HDU-8M10M	8,10	3/8	31.0	19	9,200
HDU-12M	12	1/2	35.5	22	9,200
HDU-14M15M16M	14,15,16	5/8	42.5	27	6,000
HDU-18M20M	18,20	3/4	47.0	32	6,000
HDU-22M25M	22,25	1	49.5	41	6,000
HDU-28M30M32M	28,30,32	1 1/4	51.5	46	6,000
HDU-35M38M	35,38	1 1/2	53.0	55	5,000

HDUB

Bulkhead Union
ORFS / ORFS

SAE 520601 WLO-WLNL Body with Locknut (See page A11 for WLNL)

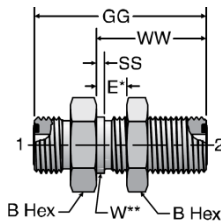

TUBE FITTING PART #	END SIZE (in.)	B HEX (in.)	E HEX (mm)	GG (mm)	SS	W DIA (mm)	WW (mm)	Dynamic Pressure (x 1,000 PSI)
HDUB-4T	1/4	13/16	13.97	48.26	1.52	14.22	31.50	9200
HDUB-6T	3/8	1	13.97	53.09	1.52	17.53	34.04	9200
HDUB-8T	1/2	1 1/8	13.97	58.42	1.52	20.57	36.58	9200
HDUB-10T	5/8	1 5/16	13.97	66.55	1.52	25.40	40.39	6000
HDUB-12T	3/4	1 1/2	13.97	69.09	1.52	30.23	41.40	6000
HDUB-16T	1	1 3/4	13.97	70.10	1.52	36.58	41.91	6000
HDUB-20T	1 1/4	2	13.97	70.10	1.52	42.93	41.91	6000
HDUB-24T	1 1/2	2 3/8	13.97	70.10	1.52	50.80	41.91	5000

**W-Bulkhead pilot diameter. Recommended clearance hole is W+0.015".

HDUB

Bulkhead Union – mm Hex
ORFS / ORFS

ISO 8434-3 BHS
SAE 52M0601
WMLO-WLNML-Body with Locknut
(See page A11 for WLNML)

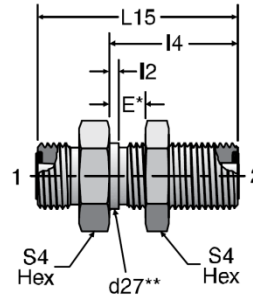

TUBE FITTING PART #	END SIZE 1 & 2		d27** (mm)	E (mm)	I4 (mm)	I2 (mm)	L15 (mm)	S4 HEX (mm)	Dynamic Pressure (x 1,000 PSI)
	(mm)	(in.)							
HDUB-6M	6	1/4	14.3	14	31.5	1.5	48.0	22	9200
HDUB-8M10M	8,10	3/8	17.5	14	34.0	1.5	53.0	27	9200
HDUB-12M	12	1/2	20.6	14	36.5	1.5	58.5	30	9200
HDUB-14M15M16M	14,15,16	5/8	25.4	14	40.5	1.5	66.5	36	6000
HDUB-18M20M	18,20	3/4	30.2	14	41.5	1.5	69.0	41	6000
HDUB-22M25M	22,25	1	36.5	14	42.0	1.5	70.0	46	6000
HDUB-28M30M32M	28,30,32	1 1/4	42.9	14	42.0	1.5	70.0	50	6000
HDUB-35M38M	35,38	1 1/2	50.8	14	42.0	1.5	70.0	60	5000

*E-Maximum bulkhead thickness.

**d27-Bulkhead pilot diameter. Recommended clearance hole is d27 + 0.4mm

HDUBMC-U

Straight Thread Bulkhead Connector
ORFS /SAE-ORB

WF5OLO-WLNL-Body with Locknut
(See page A11 for WLNL)

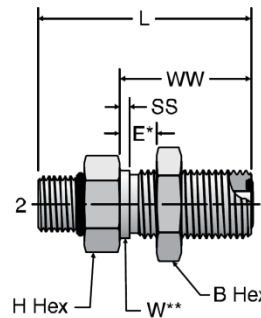

TUBE FITTING PART #	END SIZE		B HEX (in.)	E HEX (mm)	H HEX (in.)	L (mm)	SS (mm)	W DIA (mm)	WW (mm)	Dynamic Pressure (x 1,000 PSI)
	1 (in.)	2 UN/UNF - 2A								
HDUBMC4T-4U	1/4	7/16 - 20	13/16	13.97	13/16	54.36	1.52	14.22	31.50	9200
HDUBMC6T-6U	3/8	9/16 - 18	1	13.97	1	58.67	1.52	17.53	34.04	9200
HDUBMC8T-8U	1/2	3/4 - 16	1 1/8	13.97	1 1/8	66.04	1.52	20.57	36.58	9200
HDUBMC10T-10U	5/8	7/8 - 14	1 5/16	13.97	1 5/16	68.33	1.52	25.40	40.64	6000
HDUBMC12T-12U	3/4	1 1/16 - 12	1 1/2	13.97	1 1/2	73.41	1.52	30.23	41.66	6000
HDUBMC16T-16U	1	1 5/16 - 12	1 3/4	13.97	1 3/4	74.93	5.08	40.13	42.16	6000

*E-Maximum bulkhead thickness.

**W-Bulkhead pilot diameter. Recommended clearance hole is W + 0.015".

HDMC-U

Straight Thread Connector
ORFS / SAE-ORB

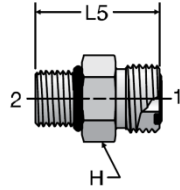

SAE 520120

TUBE FITTING PART #	END SIZE		H HEX (in.)	L5 (mm)	Dynamic Pressure (x 1,000 PSI)
	1 (in.)	2 UN/UNF - 2A			
HDMC4T-4U	1/4	7/16 - 20	5/8	28.70	9,200
HDMC4T-5U	1/4	1/2 - 20	5/8	29.46	9,200
HDMC4T-6U	1/4	9/16 - 18	3/4	30.48	9,200
HDMC4T-8U	1/4	3/4 - 16	7/8	33.53	9,200
HDMC6T-6U	3/8	9/16 - 18	3/4	32.00	9,200
HDMC6T-4U	3/8	7/16 - 20	3/4	34.04	9,200
HDMC6T-5U	3/8	1/2 - 20	3/4	30.99	9,200
HDMC6T-8U	3/8	3/4 - 16	7/8	35.05	9,200
HDMC6T-10U	3/8	7/8 - 14	1	38.61	9,200
HDMC6T-12U	3/8	1 1/16 - 12	1 1/4	42.42	9,200
HDMC8T-8U	1/2	3/4 - 16	7/8	36.58	9,200
HDMC8T-4U	1/2	7/16 - 20	7/8	36.58	9,200
HDMC8T-6U	1/2	9/16 - 18	7/8	37.59	6,000
HDMC8T-10U	1/2	7/8 - 14	1	40.39	6,000
HDMC8T-12U	1/2	1 1/16 - 12	1 1/4	44.45	6,000
HDMC8T-16U	1/2	1 5/16 - 12	1 1/2	45.47	6,000
HDMC10T-10U	5/8	7/8 - 14	1 1/16	42.93	6,000
HDMC10T-6U	5/8	9/16 - 18	1 1/16	41.40	6,000
HDMC10T-8U	5/8	3/4 - 16	1 1/16	44.96	6,000
HDMC10T-12U	5/8	1 1/16 - 12	1 1/4	46.99	6,000
HDMC10T-16U	5/8	1 5/16 - 12	1 1/2	48.01	6,000
HDMC12T-12U	3/4	1 1/16 - 12	1 1/4	48.51	6,000
HDMC12T-6U	3/4	9/16 - 16	1 1/4	44.96	6,000
HDMC12T-8U	3/4	3/4 - 16	1 1/4	48.51	6,000
HDMC12T-10U	3/4	7/8 - 14	1 1/4	50.55	6,000
HDMC12T-16U	3/4	1 5/16 - 12	1 1/2	49.53	6,000
HDMC14T-14U	7/8	1 3/16 - 12	1 3/8	48.51	6,000
HDMC16T-16U	1	1 5/16 - 12	1 1/2	50.04	6,000
HDMC16T-8U	1	3/4 - 16	1 1/2	49.78	6,000
HDMC16T-10U	1	7/8 - 14	1 1/2	52.07	6,000
HDMC16T-12U	1	1 1/16 - 12	1 1/2	54.61	6,000
HDMC16T-20U	1	1 5/8 - 12	1 7/8	52.58	6,000
HDMC16T-24U	1	1 7/8 - 12	2 1/8	54.10	6,000
HDMC20T-20U	1 1/4	1 5/8 - 12	1 7/8	52.58	6,000
HDMC20T-16U	1 1/4	1 5/16 - 12	1 7/8	57.91	6,000
HDMC20T-24U	1 1/4	1 7/8 - 12	2 1/8	54.10	5,000
HDMC24T-24U	1 1/2	1 7/8 - 12	2 1/8	54.10	5,000
HDMC24T-20U	1 1/2	1 5/8 - 12	2 1/8	59.44	5,000
HDMC32T-32U	2	2 1/2 - 12	2 3/4	58.93	3,000

HDMCL-U

Long Straight Thread Connector
ORFS-Long / SAE-ORB

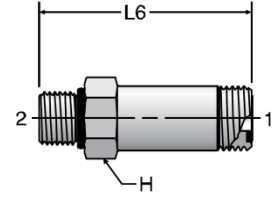

SAE 521720 (Previously 520122)

TUBE FITTING PART #	END SIZE		H HEX (in.)	L6 (mm)	Dynamic Pressure (x 1,000 PSI)
	1 (in.)	2 UN/UNF - 2A			
HDMCL4T-4U	1/4	7/16 - 20	5/8	52.58	9,200
HDMCL6T-6U	3/8	9/16 - 18	3/4	57.66	9,200
HDMCL6T-4U	3/8	7/16 - 20	3/4	60.71	9,200
HDMCL8T-8U	1/2	3/4 - 16	7/8	67.82	9,200
HDMCL10T-10U	5/8	7/8 - 14	1 1/16	79.76	6,000
HDMCL12T-12U	3/4	1 1/16 - 12	1 1/4	95.50	6,000
HDMCL16T-16U	1	1 5/16 - 12	1 1/2	105.16	6,000
HDMC20T-20U	1 1/4	1 5/8 - 12	1 7/8	120.90	6,000
HDMCL24T-24U	1 1/2	1 7/8 - 12	2 1/8	133.60	5,000

HDMC-N

Male Pipe Connector
ORFS / NPTF

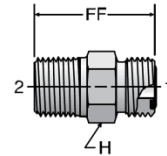

TUBE FITTING PART #	END SIZE		FF (mm)	H HEX (in.)	Dynamic Pressure (x 1,000 PSI)
	1 (in.)	2 NPTF			
HDMC4T-2N	1/4	1/8 - 27	27.18	5/8	6,000
HDMC4T-4N	1/4	1/4 - 18	32.00	5/8	6,000
HDMC4T-6N	1/4	3/8 - 18	33.53	3/4	6,000
HDMC4T-8N	1/4	1/2 - 14	38.61	7/8	6,000
HDMC6T-4N	3/8	1/4 - 18	31.75	3/4	6,000
HDMC6T-2N	3/8	1/8 - 27	29.46	3/4	6,000
HDMC6T-6N	3/8	3/8 - 18	34.04	3/4	6,000
HDMC6T-8N	3/8	1/2 - 14	39.37	7/8	6,000
HDMC8T-6N	1/2	3/8 - 18	37.59	7/8	6,000
HDMC8T-4N	1/2	1/4 - 18	37.59	7/8	6,000
HDMC8T-8N	1/2	1/2 - 14	41.66	7/8	6,000
HDMC8T-12N	1/2	3/4 - 14	42.93	1 1/8	6,000
HDMC10T-8N	5/8	1/2 - 14	46.23	1 1/16	6,000
HDMC10T-12N	5/8	3/4 - 14	46.23	1 1/8	5,500
HDMC12T-12N	3/4	3/4 - 14	49.02	1 1/4	6,000
HDMC12T-8N	3/4	1/2 - 14	49.02	1 1/4	6,000
HDMC12T-16N	3/4	1 - 11 1/2	54.10	1 3/8	4,500
HDMC16T-16N	1	1 - 11 1/2	55.63	1 1/2	4,500
HDMC16T-12N	1	3/4 - 14	50.80	1 1/2	5,500
HDMC16T-20N	1	1 1/4 - 11 1/2	58.42	1 3/4	3,000
HDMC20T-20N	1 1/4	1 1/4 - 11 1/2	58.42	1 7/8	4,000
HDMC20T-12N	1 1/4	3/4 - 14	51.31	7/8	4,500
HDMC20T-16N	1 1/4	1 - 11 1/2	57.66	1 7/8	4,500
HDMC24T-24N	1 1/2	1 1/2 - 11 1/2	60.96	2 1/8	3,000

HDCF-N

Female Pipe Connector
ORFS / Female Pipe

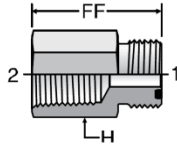

TUBE FITTING PART #	END SIZE		FF (mm)	H HEX (in.)	Dynamic Pressure (x 1,000 PSI)
	1 (in.)	2 NPTF			
HDCT4T-2N	1/4	1/8 - 27	26.16	5/8	6,000
HDCT4T-4N	1/4	1/4 - 18	31.75	3/4	6,000
HDCT6T-4N	3/8	1/4 - 18	33.02	3/4	6,000
HDCT6T-6N	3/8	3/8 - 18	34.04	7/8	6,000
HDCT8T-6N	1/2	3/8 - 18	34.04	7/8	6,000

HDMC-GED

Male Connector –BSPP
(for ISO 1179-1 Port)
ORFS / BSPP-ED

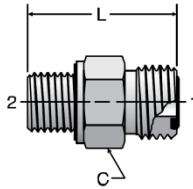

TUBE FITTING PART #	END SIZE			C HEX (mm)	L (mm)	Dynamic Pressure (x 1,000 PSI)
	1		2			
	(mm)	(in.)				
HDMC4T-2GED	6	1/4	1/8 - 28	17	25.7	9200
HDMC4T-4GED	6	1/4	1/4 - 19	19	30.5	9200
HDMC4T-6GED	6	1/4	3/8 - 19	22	31.6	9200
HDMC4T-8GED	6	1/4	1/2 - 14	27	35.4	6000
HDMC6T-4GED	8,10	3/8	1/4 - 19	19	31.9	9200
HDMC6T-2GED	8,10	3/8	1/8 - 28	19	31.1	9200
HDMC6T-6GED	8,10	3/8	3/8 - 19	22	33.0	9200
HDMC6T-8GED	8,10	3/8	1/2 - 14	27	36.5	6000
HDMC6T-12GED	8,10	3/8	3/4 - 14	32	40.3	6000
HDMC8T-6GED	12	1/2	3/8 - 19	22	34.6	9200
HDMC8T-4GED	12	1/2	1/4 - 19	22	37.5	9200
HDMC8T-8GED	12	1/2	1/2 - 14	27	38.4	6000
HDMC8T-12GED	12	1/2	3/4 - 14	32	41.9	6000
HDMC10T-8GED	14,15,16	5/8	1/2 - 14	27	41.1	6000
HDMC10T-6GED	14,15,16	5/8	3/8 - 19	27	42.4	9200
HDMC10T-12GED	14,15,16	5/8	3/4 - 14	32	44.3	6000
HDMC12T-12GED	18,20	3/4	3/4 - 14	32	46.1	6000
HDMC12T-8GED	18,20	3/4	1/2 - 14	32	48.5	6000
HDMC12T-16GED	18,20	3/4	1 - 11	41	47.5	6000
HDMC12T-20GED	18,19,20	3/4	1 1/4 - 11	50	53.0	6000
HDMC16T-16GED	22,25	1	1 - 11	41	49.8	6000
HDMC16T-12GED	22,25	1	3/4 - 14	38	50.3	6000
HDMC16T-20GED	22,25	1	1 1/4 - 11	50	53.8	6000
HDMC16T-24GED	22,25	1	1 1/2 - 11	55	57.5	5000
HDMC20T-20GED	28,30,32	1 1/4	1 1/4 - 11	50	53.8	6000
HDMC20T-16GED	28,30,32	1 1/4	1 - 11	48	55.9	6000
HDMC20T-24GED	28,30,32	1 1/4	1 1/2 - 11	55	57.6	5000
HDMC24T-24GED	38	1 1/2	1 1/2 - 11	55	57.6	5000

HDMC-M

Metric Straight Thread Connector
ORFS / ISO 6149

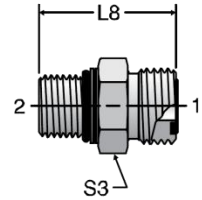

ISO 8434-3 SDS
SAE 52M0187

TUBE FITTING PART #	END SIZE			L8 (mm)	S3 HEX (mm)	Dynamic Pressure (x 1,000 PSI)
	1		2			
	(mm)	(in.)				
HDMC4T-12M15	6	1/4	M12X1.5	28.5	17	9200
HDMC4T-14M15	6	1/4	M14X1.5	29.5	19	9200
HDMC6T-12M15	8,10	3/8	M12X1.5	32.0	22	9200
HDMC6T-14M15	8,10	3/8	M14X1.5	32.0	22	9200
HDMC6T-16M15	8,10	3/8	M16X1.5	33.5	22	9200
HDMC6T-18M15	8,10	3/8	M18X1.5	36.1	24	9200
HDMC8T-14M15	12	1/2	M14X1.5	35.1	24	9200
HDMC8T-16M15	12	1/2	M16X1.5	36.6	24	9200
HDMC8T-18M15	12	1/2	M18X1.5	38.1	24	9200
HDMC8T-22M15	12	1/2	M22X1.5	39.6	27	6000
HDMC8T-27M20	12	1/2	M27X2.0	44.2	32	6000
HDMC10T-18M15	14,15,16	5/8	M18X1.5	41.0	27	6000
HDMC10T-22M15	14,15,16	5/8	M22X1.5	42.0	27	6000
HDMC10T-27M20	14,15,16	5/8	M27X2.0	47.0	32	6000
HDMC12T-22M15	18,20	3/4	M22X1.5	45.0	32	6000
HDMC12T-27M20	18,20	3/4	M27X2.0	48.5	32	6000
HDMC12T-33M20	18,20	3/4	M33X2.0	51.5	41	6000
HDMC16T-27M20	22,26	1	M27X2.0	33.6	41	6000
HDMC16T-33M20	22,25	1	M33X2.0	52.0	41	6000
HDMC20T-33M20	28,30,32	1 1/4	M33X2.0	35.1	46	5000
HDMC20T-42M20	28,30,32	1 1/4	M42X2.0	54.5	50	5000
HDMC24T-48M20	35,38	1 1/2	M48X2.0	57.0	55	5000

HDMC-MED

Male Connector – Metric
(for ISO 9974-1 Port)
ORFS / Metric-ED

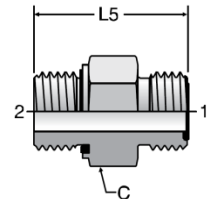

TUBE FITTING PART #	END SIZE			C HEX (mm)	L5 (mm)	Dynamic Pressure (x 1,000 PSI)
	1		2			
	(mm)	(in.)				
HDMC4T-12M15ED	6	1/4	M12X1.5	17	29.7	9200
HDMC4T-14M15ED	6	1/4	M14X1.5	19	30.5	9200
HDMC6T-14M15ED	8,10	3/8	M14X1.5	22	31.9	9200
HDMC6T-16M15ED	8,10	3/8	M16X1.5	22	31.9	9200
HDMC8T-16M15ED	12	1/2	M16X1.5	22	32.0	9200
HDMC8T-18M15ED	12	1/2	M18X1.5	24	34.6	9200
HDMC10T-22M15ED	14,15,16	5/8	M22X1.5	27	41.1	6000
HDMC12T-22M15ED	18,20	3/4	M22X1.5	32	42.7	6000
HDMC12T-27M2ED	18,20	3/4	M27X2	32	46.1	6000
HDMC16T-33M2ED	22,25	1	M33X2	41	49.8	6000
HDMC20T-42M2ED	28,30,32	1 1/4	M42X2	50	54.0	5000

HDCF-MSW

Braze Connector
ORFS / Braze Socket

ISO 8434-3 BRS
SAE 52M0104

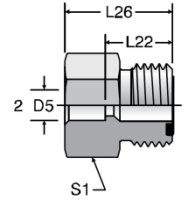

TUBE FITTING PART #	END SIZE			D5* DIA TUBE SOCKET	L22 (mm)	L26 (mm)	S1 HEX	Dynamic Pressure (x 1,000 PSI)
	1		2					
	(mm)	(in.)	(mm)					
HDCF4T-6MSW	6	1/4	6	6.15	13.5	22.0	17	9200
HDCF4T-8MSW	6	1/4	8	8.15	13.5	22.0	17	9200
HDCF6T-10MSW	8,10	3/8	10	10.15	14.5	23.0	19	9200
HDCF8T-12MSW	12	1/2	12	12.15	16.0	24.5	22	9200
HDCF10T-16MSW	14,15,16	5/8	16	16.15	19.0	27.5	27	6000
HDCF12T-20MSW	18,20	3/4	20	20.18	21.0	33.5	32	6000
HDCF16T-25MSW	22,25	1	25	25.18	24.5	38.5	41	6000
HDCF20T-30MSW	28,30,32	1 1/4	30	30.20	24.5	38.5	46	6000
HDCF24T-38MSW	35,38	1 1/2	38	38.20	24.5	38.5	55	5000

HDCF-TSW

Braze Connector
ORFS / Braze Socket

SAE 520104

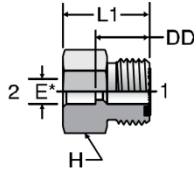

TUBE FITTING PART #	END SIZE		DD (mm)	E* DIA (mm)	H HEX (in.)	L1 (mm)	Dynamic Pressure (X 1,000 PSI)
	1 (in.)	2 (in.)					
HDCF4T-4TSW	1/4	1/4	13.46	6.60	5/8	21.84	9200
HDCF4T-6TSW	1/4	3/8	13.46	9.65	5/8	21.84	9200
HDCF6T-6TSW	3/8	3/8	14.48	9.65	3/4	22.86	9200
HDCF6T-4TSW	3/8	1/4	14.48	6.60	3/4	22.86	9200
HDCF6T-8TSW	3/8	1/2	14.48	12.95	3/4	22.86	9200
HDCF8T-8TSW	1/2	1/2	16.00	12.95	7/8	24.64	9200
HDCF8T-4TSW	1/2	1/4	16.26	6.60	7/8	24.64	9200
HDCF8T-6TSW	1/2	3/8	16.00	9.65	7/8	24.64	9200
HDCF8T-10TSW	1/2	5/8	16.00	16.00	7/8	24.64	6000
HDCF8T-12TSW	1/2	3/4	17.02	19.30	1 1/16	29.46	6000
HDCF10T-10TSW	5/8	5/8	18.80	16.00	1 1/16	27.18	6000
HDCF10T-6TSW	5/8	3/8	18.80	9.65	1 1/16	27.18	6000
HDCF10T-8TSW	5/8	1/2	18.80	12.95	1 1/16	27.18	6000
HDCF10T-12TSW	5/8	3/4	18.80	19.30	1 1/16	31.24	6000
HDCF12T-12TSW	3/4	3/4	21.08	19.30	1 1/4	33.53	6000
HDCF12T-8TSW	3/4	1/2	21.08	12.95	1 1/4	29.46	6000
HDCF12T-10TSW	3/4	5/8	21.08	16.00	1 1/4	29.46	6000
HDCF12T-16TSW	3/4	1	21.08	25.65	1 1/2	35.05	6000
HDCF16T-16TSW	1	1	24.64	25.65	1 1/2	38.61	6000
HDCF16T-8TSW	1	1/2	24.64	12.95	1 1/2	33.02	6000
HDCF16T-12TSW	1	3/4	24.64	19.30	1 1/2	37.08	6000
HDCF16T-20TSW	1	1 1/4	24.38	32.00	1 3/4	38.61	6000
HDCF20T-20TSW	1 1/4	1 1/4	24.64	32.00	1 3/4	38.61	6000
HDCF20T-16TSW	1 1/4	1	24.64	25.65	1 3/4	38.61	6000
HDCF20T-24TSW	1 1/4	1 1/2	24.64	38.35	2 1/8	38.61	5000
HDCF24T-24TSW	1 1/2	1 1/2	24.64	38.35	2 1/8	38.61	5000
HDCF24T-20TSW	1 1/2	1 1/4	24.64	32.00	2 1/8	38.61	5000

HDCW

Tube Stub Connector
ORFS / Tube Weld

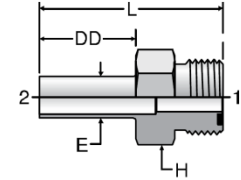

TUBE FITTING PART #	END SIZE		DD (mm)	E DIA (mm)	H HEX (in.)	L (mm)	Dynamic Pressure (x 1,000 PSI)
	1 & 2 (in.)						
HDCW-4T	1/4		22.35	6.35	5/8	40.13	5900
HDCW-6T	3/8		22.35	9.65	3/4	42.42	3800
HDCW-8T	1/2		25.40	12.70	7/8	48.01	5500
HDCW-12T	3/4		29.46	19.05	1 1/4	59.69	3500
HDCW-16T	1		28.70	25.40	1 1/4	58.93	2600
HDCW-16T61L	1		28.70	25.40	1 1/2	60.96	2600

HDSV

Tube End Reducer
ORFS Swivel / ORFS Tube End

SAE 520123 (body only)
SAE 520123A (body with large nut)

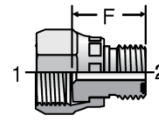

* Assembled with Crimp Nut

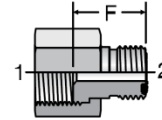

** Assembled with Large BL Nut

TUBE FITTING PART #			END SIZE		F (mm)	Dynamic Pressure (x 1,000 PSI)
TRLON	TRLON	TRLO	1 (in.)	2 (in.)		
*One Piece Design (With Crimp Nut)	**Two Piece Design (With Large Nut)	***Body Only (For Two-Piece Design Only)				
HDSVA6T-4T	-	-	3/8	1/4	19.56	9200
-	HDSVA8T-4T	HDSV8T-4T	1/2	1/4	22.10	9200
HDSVA8T-6T	-	-	1/2	3/8	22.61	9200
-	HDSVA10T-4T	DHSV10T-4T	5/8	1/4	23.11	6000
-	HDSVA10T-6T	HDSV10T-6T	5/8	3/8	23.88	6000
-	HDSVA10T-8T	HDSV10T-8T	5/8	1/2	25.40	6000
-	HDSVA12T-4T	HDSV12T-4T	3/4	1/4	24.89	6000
-	HDSVA12T-6T	HDSV12T-6T	3/4	3/8	25.91	6000
-	HDSVA12T-8T	HDSV12T-8T	3/4	1/2	27.43	6000
HDSVA12T-10T	-	-	3/4	5/8	29.46	6000
-	HDSVA16T-8T	HDSV16T-8T	1	1/2	28.96	6000
-	HDSVA16T-10T	HDSV16T-10T	1	5/8	32.00	6000
HDSVA16T-12T	-	-	1	3/4	33.02	6000
-	HDSVA20T-12T	HDSV20T-12T	1 1/4	3/4	33.53	5000
HDSVA20T-16T	-	-	1 1/4	1	34.04	5000
-	HDSVA24T-12T	-	1 1/2	3/4	33.53	4000
-	HDSVA24T-16T	HDSV24T-16T	1 1/2	1	34.04	4000
-	HDSVA24T-20T	HDSV24T-20T	1 1/2	1 1/4	34.04	4000
-	HDSVA32T-20T	HDSV32T-20T	2	1 1/4	36.07	3000
-	HDSVA32T-24T	HDSV32T-24T	2	1 1/2	36.07	3000

* Assembled with crimp nut.

** Assembled with page BL nut.

*** To order reducer without large nut (body only) remove the "N" from the part number (i.e., TRLO).

HDMCSV

Tube End Extender / Expander
ORFS / ORFS Swivel

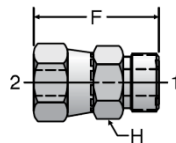

TUBE FITTING PART #	END SIZE		F (mm)	H HEX (in.)	Dynamic Pressure (x 1,000 PSI)
	1 (in.)	2 (in.)			
HDMCSV4T-4SV	1/4	1/4	33.78	5/8	9200
HDMCSV6T-6SV	3/8	3/8	36.58	3/4	9200
HDMCSV6T-4SV	3/8	1/4	34.80	3/4	9200
HDMCSV8T-8SV	1/2	1/2	42.42	7/8	9200
HDMCSV8T-6SV	1/2	3/8	41.15	7/8	9200
HDMCSV10T-8SV	5/8	1/2	45.97	1 1/16	6000
HDMCSV12T-10SV	3/4	5/8	50.55	1 1/4	6000
HDMCSV16T-12SV	1	3/4	54.86	1 1/2	6000
HDMCSV20T-16SV	1 1/4	1	57.91	1 3/4	5000
HDMCSV24T-20SV	1 1/2	1 1/4	59.69	2 1/8	4000

HDSVU

Swivel Nut Union
ORFS Swivel / ORFS Swivel

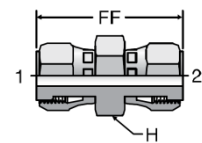

TUBE FITTING PART #	END SIZE		FF (mm)	H HEX (in.)	Dynamic Pressure (x 1,000 PSI)
	1 (in.)	2 (in.)			
HDSVU4T-4SV	1/4	1/4	40.39	5/8	9200
HDSVU6T-6SV	3/8	3/8	44.96	3/4	9200
HDSVU8T-8SV	1/2	1/2	53.85	7/8	9200
HDSVU10T-10SV	5/8	5/8	61.47	1 1/16	6000
HDSVU12T-12SV	3/4	3/4	69.60	1 1/4	6000
HDSVU16T-16SV	1	1	74.93	1 7/16	6000

HDSVMC

Straight Thread Swivel Connector
ORFS Swivel / SAE - ORB

SAE 520181

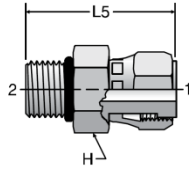

TUBE FITTING PART #	END SIZE		H HEX (in.)	L5 (mm)	Dynamic Pressure (x 1,000 PSI)
	1 (in.)	2 UN/UNF - 2A			
HDSVMC4T-4U	1/4	7/16 - 20	5/8	37.08	9200
HDSVMC6T-6U	3/8	9/16 - 18	3/4	39.88	9200
HDSVMC8T-8U	1/2	3/4 - 16	7/8	49.53	9200
HDSVMC10T-10U	5/8	7/8 - 14	1 1/16	54.10	6000
HDSVMC12T-12U	3/4	1 1/16 - 12	1 1/4	59.44	6000
HDSVMC16T-16U	1	1 5/16 - 12	1 1/2	67.56	6000
HDSVMC20T-20U	1 1/4	1 5/8 - 12	1 7/8	67.56	5000

HFDVCF

Straight Thread Swivel Female Connector
ORFS Swivel / SAE-ORB

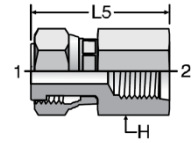

TUBE FITTING PART #	END SIZE		H HEX (in.)	L5 (mm)	Dynamic Pressure (x 1,000 PSI)
	1 (in.)	2 UN/UNF - 2B			
HDSVCF4T-4U	1/4	7/16 - 20	3/4	35.05	6000
HDSVCF4T-6U	1/4	9/16 - 18	13/16	36.83	6000
HDSVCF6T-4U	3/8	7/16 - 20	3/4	38.35	6000
HDSVCF8T-4U	1/2	7/16 - 20	7/8	39.88	6000

HDSVMC-N

Pipe Thread Swivel Connector
ORFS Swivel / NPTF

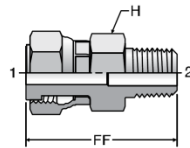

TUBE FITTING PART #	END SIZE		FF (mm)	H HEX (in.)	Dynamic Pressure (x 1,000 PSI)
	1 (in.)	2 NPTF			
HDSVMC4T-2N	1/4	1/8 - 27	33.78	5/8	6000
HDSVMC4T-4N	1/4	1/4 - 18	38.61	5/8	6000
HDSVMC6T-4N	3/8	1/4 - 18	42.93	3/4	6000
HDSVMC6T-6N	3/8	3/8 - 18	42.42	3/4	6000
HDSVMC8T-6N	1/2	3/8 - 18	49.53	3/4	6000
HDSVMC8T-8N	1/2	1/2 - 14	54.36	7/8	6000
HDSVMC10T-8N	5/8	1/2 - 14	58.17	1 1/16	6000
HDSVMC12T-12N	3/4	3/4 - 14	60.20	1 1/4	5500
HDSVMC16T-16N	1	1 - 11 1/2	72.90	1 1/2	4500

HDSVCF-N

Female Pipe Thread Swivel Connector
ORFS Swivel / NPTF

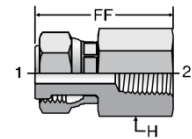

TUBE FITTING PART #	END SIZE		FF (mm)	H (in.)	Dynamic Pressure (x 1,000 PSI)
	1 (in.)	2 NPTF			
HDSVCF4T-4N	1/4	1/4 - 18	37.59	3/4	6000
HDSVCF6T-4N	3/8	1/4 - 18	40.64	7/8	6000
HDSVCF8T-4N	1/2	1/4 - 18	44.45	7/8	6000

HDSVMC-M

Swivel ISO 6149 Connector
ORFS Swivel / ISO 6149

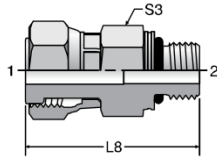

TUBE FITTING PART #	END SIZE			L8 (mm)	S3 HEX (mm)	Dynamic Pressure (x 1,000 PSI)
	1		2			
	(mm)	(in.)	ISO 261			
HDSVMC4T-12M15	6	1/4	M12X1.5	37.0	17	9200
HDSVMC6T-12M15	8,10	3/8	M12X1.5	39.0	17	9200
HDSVMC6T-14M15	8,10	3/8	M14X1.5	38.0	19	9200
HDSVMC6T-16M15	8,10	3/8	M16X1.5	43.5	22	9200
HDSVMC8T-16M15	12	1/2	M16X1.5	48.0	22	9200
HDSVMC10T-22M15	14,15,16	5/8	M22X1.5	53.0	27	6000
HDSVMC10T-27M2	14,15,16	5/8	M27X2	57.0	32	6000
HDSVMC12T-27M2	18,20	3/4	M27X2	59.5	32	6000
HDSVMC16T-33M2	22,25	1	M33X2	67.5	41	6000

HDSVMC-MED

Swivel Metric Connector
ORFS Swivel / Metric-ED

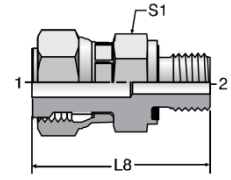

TUBE FITTING PART #	END SIZE			L8 (mm)	S1 HEX (mm)	Dynamic Pressure (x 1,000 PSI)
	1		2			
	(mm)	(in.)	Metric			
HDSVMC4T-12M15ED	6	1/4	M12X1.5	38.2	17	9200
HDSVMC6T-14M15ED	8,10	3/8	M14X1.5	40.2	19	9200
HDSVMC8T-16M15ED	12	1/2	M16X1.5	47.3	22	9200
HDSVMC10T-22M15ED	14,15,16	5/8	M22X1.5	51.8	27	6000
HDSVMC12T-27M2ED	18,20	3/4	M27X2	57.2	32	6000
HDSVMC16T-33M2ED	22,25	1	M33X2	67.0	41	6000

HDSVMC-GED

Swivel BSPP Connector
ORFS Swivel / BSPP-ED

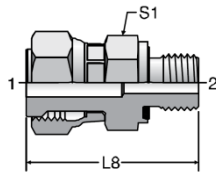

TUBE FITTING PART #	END SIZE			L8 (mm)	S1 HEX (mm)	Dynamic Pressure (x 1,000 PSI)
	1		2			
	(mm)	(in.)	BSPP			
HDSVMC4T-2GED	6	1/4	1/8	34.0	14	7200
HDSVMC6T-4GED	8,10	3/8	1/4	40.2	19	9200
HDSVMC8T-6GED	12	1/2	3/8	47.3	22	9200
HDSVMC10T-8GED	14,15,16	5/8	1/2	51.8	27	6000
HDSVMC12T-12GED	18,20	3/4	3/4	57.2	32	6000
HDSVMC16T-16GED	22,25	1	1	67.0	46	6000

HDLBUB

45° Bulkhead Union Elbow
ORFS / ORFS

SAE 520801

WNLO-WLNL-Body with Locknut
(See page A11 for WLNL)

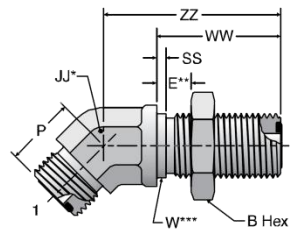

TUBE FITTING PART #	END SIZE		B HEX (in.)	E MAX (mm)	JJ (in.)	P (mm)	SS (mm)	W DIA (mm)	WW (mm)	ZZ (mm)	Dynamic Pressure (x 1,000 PSI)
	1 (in.)	2 (in.)									
HDLBUB-4T	1/4	1/4	13/16	13.97	9/16	16.00	1.52	14.22	31.50	43.94	9200
HDLBUB-6T	3/8	3/8	1	13.97	3/4	19.05	1.52	17.53	34.04	48.51	9200
HDLBUB-8T	1/2	1/2	1 1/8	13.97	3/4	20.57	1.52	20.57	36.58	51.05	9200
HDLBUB-10T	5/8	5/8	1 5/16	13.97	1 1/16	23.62	1.52	25.40	40.39	56.39	6000
HDLBUB-12T	3/4	3/4	1 1/2	13.97	1 3/16	25.91	1.52	30.23	41.40	60.45	6000
HDLBUB-16T	1	1	1 3/4	13.97	1 7/16	29.97	1.52	36.58	41.91	65.02	6000
HDLBUB-20T	1 1/4	1 1/4	2	13.97	1 5/8	32.00	1.52	42.93	41.91	67.06	5000
HDLBUB-24T	1 1/2	1 1/2	2 3/8	13.97	1 7/8	37.08	1.52	50.80	41.91	67.06	4000

* JJ-Across wrench flats.

** E- Maximum bulkhead thickness.

*** W- Bulkhead pilot diameter. Recommended clear nace hole is W + 0.015".

HDLBUB

45° Bulkhead Union Elbow – mm Hex
ORFS / ORFS

ISO 8434-3 BHE45
SAE 52M0801
WNMLO-WLNML – Body with Locknut
(See page –A11 for WLNML)

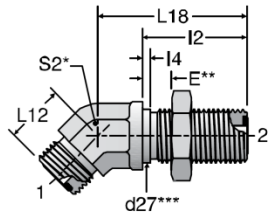

HDLB-SV

45° Swivel Nut Elbow
ORFS / ORFS Swivel

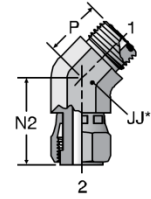

* JJ – Across Wrench Flats

TUBE FITTING PART #	END SIZE 1 & 2		d27*** (mm)	E (mm)	I2 (mm)	I4 (mm)	L12 (mm)	L18 (mm)	S2 (mm)	Dynamic Pressure (x 1,000 PSI)
	(mm)	(in.)								
HDLBUB-6M	6	1/4	14.3	14	31.5	1.5	16.0	44.0	14	9200
HDLBUB-8M10M	8,10	3/8	17.5	14	34.0	1.5	19.0	48.5	19	9200
HDLBUB-12M	12	1/2	20.6	14	36.5	1.5	20.5	51.0	19	9200
HDLBUB-14M15M16M	14,15,16	5/8	25.4	14	40.5	1.5	23.5	56.5	27	6000
HDLBUB-18M20M	18,20	3/4	30.2	14	41.5	1.5	26.0	60.5	30	6000
HDLBUB-22M25M	22,25	1	36.5	14	42.0	1.5	30.0	65.0	36	6000
HDLBUB-28M30M32M	28,30,32	1 1/4	42.9	14	42.0	1.5	32.0	67.0	41	5000
HDLBUB-35M38M	35,38	1 1/2	50.8	14	42.0	1.5	37.0	67.0	50	4000

* S2- Across Wrench Flats.

** E- Maximum bulkhead thickness.

*** d27- Bulkhead pilot diameter. Recommended clearance hole is d27 + 0.4mm.

TUBE FITTING PART #	END SIZE		JJ (in.)	N2 (mm)	P (mm)	Dynamic Pressure (x 1,000 PSI)
	1 & 2 (in.)					
HDLB4T-4SV	1/4		9/16	25.15	16.00	9200
HDLB6T-6SV	3/8		3/4	28.45	18.80	9200
HDLB8T-8SV	1/2		3/4	37.85	20.32	9200
HDLB10T-10SV	5/8		1 1/16	38.86	23.37	6000
HDLB12T-12SV	3/4		1 3/16	43.94	25.91	6000
HDLB16T-16SV	1		1 7/16	47.50	29.97	6000
HDLB20T-20SV	1 1/4		1 5/8	50.29	32.00	5000
HDLB24T-24SV	1 1/2		1 7/8	52.32	36.83	4000

HDLB-UP

45° Straight Thread Elbow
ORFS / SAE-ORB

SAE 520320

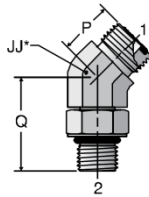

* JJ – Across Hex Flats

TUBE FITTING PART #	END SIZE		JJ (in.)	P (mm)	Q (mm)	Dynamic Pressure (x 1,000 PSI)
	1 (in.)	2 UN/UNF - 2A				
HDLB4T-4UP	1/4	7/16 - 20	9/16	16.00	29.97	6000
HDLB4T-6UP	1/4	9/16 - 18	3/4	17.53	33.02	6000
HDLB6T-6UP	3/8	9/16 - 18	3/4	19.05	33.02	6000
HDLB6T-4UP	3/8	7/16 - 20	3/4	19.05	30.99	6000
HDLB6T-8UP	3/8	3/4 - 16	3/4	19.05	36.58	6000
HDLB8T-8UP	1/2	3/4 - 16	3/4	20.57	36.58	6000
HDLB8T-6UP	1/2	9/16 - 18	3/4	20.57	32.51	6000
HDLB8T-10UP	1/2	7/8 - 14	3/4	21.59	44.45	6000
HDLB10T-10UP	5/8	7/8 - 14	1 1/16	23.62	44.45	6000
HDLB10T-8UP	5/8	3/4 - 16	1 1/16	23.62	39.88	6000
HDLB10T-12UP	5/8	1 1/16 - 12	1 3/16	24.38	50.04	6000
HDLB12T-12UP	3/4	1 1/16 - 12	1 3/16	25.91	50.04	6000
HDLB12T-10UP	3/4	7/8 - 14	1 3/16	25.91	45.97	6000
HDLB12T-16UP	3/4	1 5/16 - 12	1 7/16	29.46	52.58	5500
HDLB16T-16UP	1	1 5/16 - 12	1 7/16	29.97	52.58	5500
HDLB16T-10UP	1	7/8 - 14	1 7/16	29.97	51.56	6000
HDLB16T-12UP	1	1 1/16 - 12	1 7/16	29.97	51.56	6000
HDLB16T-20UP	1	1 5/8 - 12	1 5/8	32.00	53.59	4000
HDLB20T-20UP	1 1/4	1 5/8 - 12	1 5/8	32.00	53.59	4000
HDLB24T-24UP	1 1/2	1 7/8 - 12	1 7/8	37.08	53.59	4000

HDLB-MP

45° Metric Straight Thread Elbow
ORFS / ISO 6149

ISO 8434-3 SDE45
SAE 52M0387

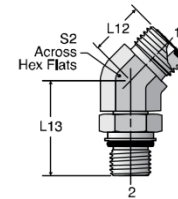

* S2 – Across Hex Flats

TUBE FITTING PART #	END SIZE			L12 (mm)	L13 (mm)	S2 (mm)	Dynamic Pressure (x 1,000 PSI)
	1		2				
	(mm)	(in.)	ISO 261				
HDLB4T-12M15P	6	1/4	M12X1.5	16.0	30.0	14	6000
HDLB4T-14M15P	6	1/4	M14X1.5	17.5	31.5	17	6000
HDLB6T-16M15P	8,10	3/8	M16X1.5	19.0	33.5	17	6000
HDLB8T-18M15P	12	1/2	M18X1.5	20.5	37.0	19	6000
HDLB10T-22M15P	14,15,16	5/8	M22X1.5	23.5	44.0	27	6000
HDLB12T-27M2P	18,20	3/4	M27X2	26.0	50.5	27	6000
HDLB16T-33M2P	22,25	1	M33X2	30.0	52.5	36	5000
HDLB20T-42M2P	28,30,32	1 1/4	M42X2	32.0	54.0	41	4000
HDLB24T-48M2P	35,38	1 1/2	M48X2	37.0	56.5	50	4000

HDLB-N

45° Male Elbow
ORFS / NPTF

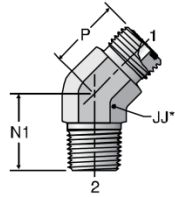

* JJ – Across Wrench Flats

TUBE FITTING PART #	END SIZE		JJ (in.)	N1 (mm)	P (mm)	Dynamic Pressure (x 1,000 PSI)
	1 (in.)	2 NPTF				
HDLB4T-2N	1/4	1/8 - 27	9/16	16.26	16.00	6000
HDLB4T-4N	1/4	1/4 - 18	9/16	21.84	17.27	6000
HDLB6T-4N	3/8	1/4 - 18	3/4	22.10	18.80	6000
HDLB6T-6N	3/8	3/8 - 18	3/4	22.10	18.80	6000
HDLB8T-6N	1/2	3/8 - 18	3/4	24.13	20.32	6000
HDLB8T-8N	1/2	1/2 - 14	7/8	29.72	21.84	6000
HDLB10T-8N	5/8	1/2 - 14	1 1/16	29.72	23.37	6000
HDLB12T-12N	3/4	3/4 - 14	1 5/16	33.02	25.91	4000
HDLB16T-16N	1	1 - 11 1/2	1 7/16	37.59	29.97	3000
HDLB20T-20N	1 1/4	1 1/4 - 11 1/2	1 5/8	42.42	32.00	2500

HDLB-GP

Male 45° Elbow – BSPP
(for ISO 1179-1 Port)
ORFS / BSPP-ORR

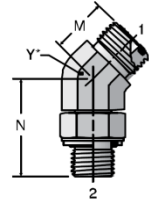

* Y – Across Hex Flats

TUBE FITTING PART #	END SIZE			M (mm)	N (mm)	Y (mm)	Dynamic Pressure (x 1,000 PSI)
	1		2				
	(mm)	(in.)					
HDLB4T-2GP	6	1/4	1/8 - 28	16.0	27.5	14	4000
HDLB4T-4GP	6	1/4	1/4 - 19	17.5	32.0	19	4000
HDLB6T-4GP	8,10	3/8	1/4 - 19	19.0	32.0	19	4000
HDLB6T-6GP	8,10	3/8	3/8 - 19	19.0	33.5	19	4000
HDLB6T-8GP	8,10	3/8	1/2 - 14	19.5	43.5	27	4000
HDLB8T-6GP	12	1/2	3/8 - 19	20.5	33.5	19	4000
HDLB8T-8GP	12	1/2	1/2 - 14	21.0	43.5	27	4000
HDLB10T-8GP	14,15,16	5/8	1/2 - 14	23.5	43.5	27	4000
HDLB10T-12GP	14,15,16	5/8	3/4 - 14	24.5	46.5	30	4000
HDLB12T-12GP	18,20	3/4	3/4 - 14	26.0	46.5	30	4000
HDLB12T-16GP	18,20	3/4	1 - 11	26.0	51.0	37	4000
HDLB16T-16GP	22,25	1	1 - 11	30.0	51.0	37	4000

HDL

Union Elbow
ORFS / ORFS

SAE 520201

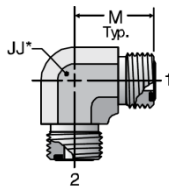

* JJ – Across Wrench Flats

TUBE FITTING PART #	END SIZE		JJ (in.)	M (mm)	Dynamic Pressure (x 1,000 PSI)
	1 (in.)	2 (in.)			
HDL-4T	1/4	1/4	9/16	21.59	9200
HDL-6T	3/8	3/8	3/4	24.89	9200
HDL-8T	1/2	1/2	3/4	27.94	9200
HDL-10T	5/8	5/8	1 1/16	33.53	6000
HDL-12T	3/4	3/4	1 3/16	37.59	6000
HDL-16T	1	1	1 7/16	41.40	6000
HDL-20T	1 1/4	1 1/4	1 5/8	44.45	5000
HDL-24T	1 1/2	1 1/2	1 7/8	49.02	4000
HDL-32T	2	2	2 1/2	70.10	3000

HDL-M

Union Elbow – mm Hex
ORFS / ORFS

ISO 8434-3 E
SAE 52M0201

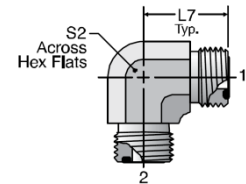

TUBE FITTING PART #	END SIZE		L7 (mm)	S2 (mm)	Dynamic Pressure (x 1,000 PSI)
	1 & 2				
	(mm)	(in.)			
HDL-6M	6	1/4	21.5	14	9200
HDL-8M10M	8,10	3/8	25.0	19	9200
HDL-12M	12	1/2	28.0	19	9200
HDL-14M15M16M	14,15,16	5/8	33.5	27	6000
HDL-18M20M	18,20	3/4	37.5	30	6000
HDL-22M25M	22,25	1	41.5	36	6000
HDL-28M30M32M	28,30,32	1 1/4	44.5	41	5000
HDL-35M38M	35,38	1 1/2	49.0	50	4000

HDLUB

Bulkhead Union Elbow
ORFS / ORFS

SAE 520701

WELO-WLNL – Body with Locknut
(See page A11 for WLNL)

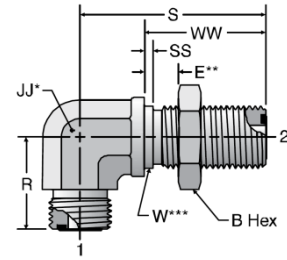

TUBE FITTING PART #	END SIZE		B HEX (in.)	E MAX (in.)	JJ (in.)	R (mm)	S (mm)	SS (mm)	W (mm)	WW (mm)	Dynamic Pressure (x 1,000 PSI)
	1 (in.)	2 (in.)									
HDLUB-4T	1/4	1/4	13/16	13.97	9/16	22.61	46.99	1.52	14.22	31.50	9200
HDLUB-6T	3/8	3/8	1	13.97	3/4	25.91	52.07	1.52	17.53	34.04	9200
HDLUB-8T	1/2	1/2	1 1/8	13.97	3/4	28.96	55.63	1.52	20.57	36.58	9200
HDLUB-10T	5/8	5/8	1 5/16	13.97	1 1/16	34.54	62.99	1.52	25.40	40.39	6000
HDLUB-12T	3/4	3/4	1 1/2	13.97	1 3/16	38.61	67.06	1.52	30.23	41.40	6000
HDLUB-16T	1	1	1 3/4	13.97	1 7/16	42.42	71.12	1.52	36.58	41.91	6000
HDLUB-20T	1 1/4	1 1/4	2	13.97	1 5/8	45.47	75.44	1.52	42.93	41.91	5000
HDLUB-24T	1 1/2	1 1/2	2 3/8	13.97	1 7/8	49.53	79.50	1.52	50.80	41.91	4000

* JJ-Across wrench flats.

** E- Maximum bulkhead thickness.

*** W- Bulkhead pilot diameter. Recommended clear nace hole is W + 0.015".

HDLUB-M

Bulkhead Union Elbow – mm Hex
ORFS /ORFS

ISO 8434-3 BHE

SAE 52M0701

WEMLOWLNML – Body with Locknut
(See page A11 for WLNML)

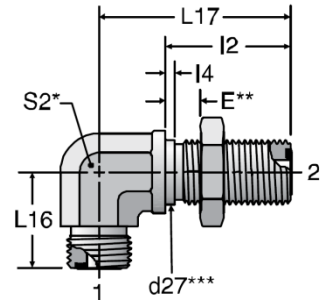

TUBE FITTING PART #	END SIZE		d27*** (mm)	E (mm)	I2 (mm)	I4 (mm)	L16 (mm)	L17 (mm)	S2 (mm)	Dynamic Pressure (x 1,000 PSI)
	1 & 2									
	(mm)	(in.)								
HDLUB-6M	6	1/4	14.3	14	31.5	1.5	22.5	47.0	14	9200
HDLUB-8M10M	8,10	3/8	17.5	14	34.0	1.5	26.0	52.0	19	9200
HDLUB-12M	12	1/2	20.6	14	36.5	2.5	29.0	55.5	19	9200
HDLUB-14M15M16M	14,15,16	5/8	25.4	14	40.5	2.5	34.5	63.0	27	6000
HDLUB-18M20M	18,20	3/4	30.2	14	41.5	3.0	38.5	67.0	30	6000
HDLUB-22M25M	22,25	1	36.5	14	42.0	3.0	42.5	71.0	36	6000
HDLUB-28M30M32M	28,30,32	1 1/4	42.9	14	42.0	3.0	45.5	75.5	41	5000
HDLUB-35M38M	35,38	1 1/2	50.8	14	42.0	3.0	49.5	79.5	50	4000

*S2 –Across wrench flats.

**E-Maximum bulkhead thickness.

***d27-Bulkhead pilot diameter. Recommended clearance is d27 + 0.4mm.

HDL-SV

Swivel Nut Elbow
ORFS / ORFS Swivel

SAE 520221

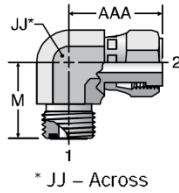

* JJ – Across

TUBE FITTING PART #	END SIZE		AAA (mm)	JJ (in.)	M (mm)	Dynamic Pressure (x 1,000 PSI)
	1 (in.)	2 (in.)				
HDL4T-4SV	1/4	1/4	27.18	9/16	21.59	9200
HDL6T-6SV	3/8	3/8	29.72	3/4	24.89	9200
HDL8T-8SV	1/2	1/2	38.10	3/4	27.94	9200
HDL10T-10SV	5/8	5/8	40.89	1 1/16	33.53	6000
HDL12T-12SV	3/4	3/4	46.48	1 3/16	37.59	6000
HDL16T-16SV	1	1	53.59	1 7/16	41.66	6000
HDL20T-20SV	1 1/4	1 1/4	57.91	1 5/8	44.45	5000
HDL24T-24SV	1 1/2	1 1/2	61.21	1 7/8	48.77	4000

HDL-SV

Swivel Nut Elbow – mm Hex
ORFS / ORFS Swivel

ISO 8434-3 SWE
SAE 52M0221

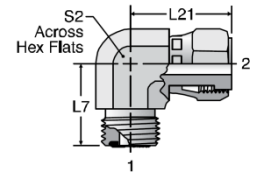

* S2 – Across Hex Flats

TUBE FITTING PART #	END SIZE		L7 (mm)	L21 (mm)	S2 (mm)	Dynamic Pressure (x 1,000 PSI)
	1 (mm)	2 (in.)				
HDL6M-4SV	6	1/4	21.5	27.2	14	9200
HDL8M10M-6SV	8,10	3/8	25.0	29.7	19	9200
HDL12M-8SV	12	1/2	28.0	38.0	19	9200
HDL14M15M16M-10SV	14,15,16	5/8	33.5	41.0	27	6000
HDL18M20M-12SV	18,20	3/4	37.5	46.5	30	6000
HDL22M25M-16SV	22,25	1	41.6	53.5	36	6000
HDL28M30M32M-20SV	28,30,32	1 1/4	44.5	58.0	41	4000
HDL35M38M-24SV	35,38	1 1/2	48.8	61.0	50	4000

HDL-UP

Straight Thread Elbow
ORFS / SAE-ORB

SAE 520220

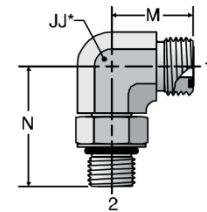

* JJ – Across

TUBE FITTING PART #	END SIZE		JJ (in.)	M (mm)	N (mm)	Dynamic Pressure (x 1,000 PSI)
	1 (in.)	2 UN/UNF - 2A				
HDL4T-4UP	1/4	7/16 - 20	9/16	21.59	33.02	6000
HDL4T-6UP	1/4	9/16 - 18	9/16	23.62	37.08	6000
HDL4T-8UP	1/4	3/4 - 16	3/4	24.89	40.39	6000
HDL6T-6UP	3/8	9/16 - 18	3/4	24.89	37.08	6000
HDL6T-4UP	3/8	7/16 - 20	3/4	24.89	35.05	6000
HDL6T-5UP	3/8	1/2 - 20	3/4	24.89	35.05	6000
HDL6T-8UP	3/8	3/4 - 16	3/4	26.42	40.39	6000
HDL6T-10UP	3/8	7/8 - 14	7/8	29.21	50.04	6000
HDL6T-12UP	3/8	1 1/16 - 12	1 1/16	32.51	55.12	6000
HDL8T-8UP	1/2	3/4 - 16	3/4	27.94	40.39	6000
HDL8T-6UP	1/2	9/16 - 18	3/4	27.94	36.58	6000
HDL8T-10UP	1/2	7/8 - 14	7/8	30.73	50.04	6000
HDL8T-12UP	1/2	1 1/16 - 12	1 3/16	33.53	55.12	6000
HDL10T-10UP	5/8	7/8 - 14	1 1/16	33.53	50.04	6000
HDL10T-8UP	5/8	3/4 - 16	1 1/16	33.53	45.97	6000
HDL10T-12UP	5/8	1 1/16 - 12	1 3/16	36.07	55.12	6000
HDL12T-12UP	3/4	1 1/16 - 12	1 3/16	37.59	55.12	6000
HDL12T-8UP	3/4	3/4 - 16	1 3/16	37.59	46.48	6000
HDL12T-10UP	3/4	7/8 - 14	1 3/16	37.59	51.05	6000
HDL12T-16UP	3/4	1 5/16 - 12	1 7/16	40.89	59.44	5500
HDL16T-16UP	1	1 5/16 - 12	1 7/16	41.40	59.44	5500
HDL16T-12UP	1	1 1/16 - 12	1 7/16	41.40	58.42	6000
HDL16T-20UP	1	1 5/8 - 12	1 5/8	44.45	61.98	4000
HDL20T-20UP	1 1/4	1 5/8 - 12	1 5/8	44.45	61.98	4000
HDL20T-16UP	1 1/4	1 5/16 - 12	1 5/8	44.45	61.98	4000
HDL20T-24UP	1 1/4	1 7/8 - 12	1 7/8	49.02	66.04	4000
HDL24T-24UP	1 1/2	1 7/8 - 12	1 7/8	49.02	66.04	4000
HDL24T-20UP	1 1/2	1 5/8 - 12	1 7/8	49.02	66.04	4000
HDL32T-32UP	2	2 1/2 - 12	2 1/2	70.10	77.98	2500

HDSVL

Straight Thread Swivel Elbow
ORFS Swivel / SAE-ORB

SAE 520281

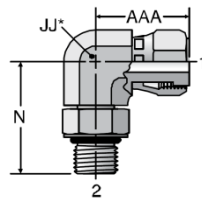

* JJ – Across Wrench Flats

TUBE FITTING PART #	END SIZE		AAA (mm)	JJ (in.)	N (mm)	Dynamic Pressure (x 1,000 PSI)
	1 (in.)	2 UN/UNF - 2A				
HDSVL4SV-4UP	1/4	7/16 - 20	26.42	9/16	33.02	6000
HDSVL6SV-6UP	3/8	9/16 - 18	29.72	3/4	37.08	6000
HDSVL8SV-8UP	1/2	3/4 - 16	38.10	3/4	40.39	6000
HDSVL10SV-10UP	5/8	7/8 - 14	41.91	1 1/16	50.04	6000
HDSVL12SV-12UP	3/4	1 1/16 - 12	45.47	1 1/16	55.12	6000
HDSVL16SV-16UP	1	1 5/16 - 12	52.58	1 5/16	59.44	5500
HDSVL20SV-20UP	1 1/4	1 5/8 - 12	57.91	1 5/8	61.98	4000
HDSVL24SV-24UP	1 1/2	1 7/8 - 12	60.96	1 7/8	66.04	4000

HDLL

Long Straight Thread Elbow
ORFS-Long / SAE-ORB

SAE 521520

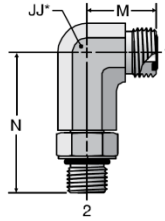

* JJ – Across
Wrench Flats

HDL-N

Male Pipe Elbow
ORFS / NPTF

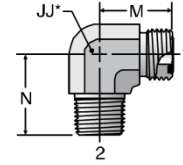

* JJ – Across
Wrench Flats

TUBE FITTING PART #	END SIZE		JJ (in.)	M (mm)	N (mm)	Dynamic Pressure (x 1,000 PSI)
	1 (in.)	2 UN/UNF - 2A				
HDLL4T-4UP	1/4	7/16 - 20	9/16	21.59	56.39	6000
HDLL6T-6UP	3/8	9/16 - 18	3/4	24.89	66.55	6000
HDLL8T-8UP	1/2	3/4 - 16	3/4	27.94	74.93	6000
HDLL10T-10UP	5/8	7/8 - 14	1 1/16	33.53	88.90	6000
HDLL12T-12UP	3/4	1 1/16 - 12	1 3/16	37.59	101.09	6000
HDLL16T-16UP	1	1 5/16 - 12	1 5/8	41.40	114.05	5500

TUBE FITTING PART #	END SIZE		JJ (in.)	M (mm)	N (mm)	Dynamic Pressure (x 1,000 PSI)
	1 (in.)	2 NPTF				
HDL4T-2N	1/4	1/8 - 27	9/16	21.59	20.32	6000
HDL4T-4N	1/4	1/4 - 18	9/16	21.59	28.45	6000
HDL4T-6N	1/4	3/8 - 18	3/4	24.64	30.99	6000
HDL4T-8N	1/4	1/2 - 14	7/8	27.18	37.34	6000
HDL6T-4N	3/8	1/4 - 18	3/4	24.89	27.69	6000
HDL6T-6N	3/8	3/8 - 18	3/4	24.89	30.99	6000
HDL6T-8N	3/8	1/2 - 14	7/8	29.21	37.34	6000
HDL8T-6N	1/2	3/8 - 18	3/4	27.94	30.99	6000
HDL8T-4N	1/2	1/4 - 18	3/4	27.94	30.99	6000
HDL8T-8N	1/2	1/2 - 14	7/8	27.94	37.34	6000
HDL8T-12N	1/2	3/4 - 14	1 1/16	33.53	40.39	4000
HDL10T-8N	5/8	1/2 - 14	1 1/16	33.27	37.34	6000
HDL10T-6N	5/8	3/8 - 18	1 1/16	33.27	32.51	6000
HDL10T-12N	5/8	3/4 - 14	1 3/16	35.81	40.39	4000
HDL12T-12N	3/4	3/4 - 14	1 3/16	37.34	40.39	4000
HDL12T-8N	3/4	1/2 - 14	1 3/16	37.34	40.39	6000
HDL12T-16N	3/4	1 - 11 1/2	1 5/16	41.15	50.04	3000
HDL16T-16N	1	1 - 11 1/2	1 7/16	41.66	50.04	3000
HDL16T-12N	1	3/4 - 14	1 7/16	41.66	45.21	4000
HDL20T-20N	1 1/4	1 1/4 - 11 1/2	1 5/8	44.70	60.45	2500
HDL24T-24N	1 1/2	1 1/2 - 11 1/2	1 7/8	48.77	67.06	2500
HDL24T-20N	1 1/2	1 1/4 - 11 1/2	1 7/8	48.77	66.29	2500

HDL-MPK

90° Metric Straight Thread Elbow
ORFS / ISO 6149

ISO 8434-3 SDE
SAE 52M0287

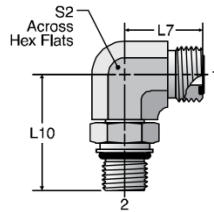

TUBE FITTING PART #	END SIZE			L7 (mm)	L10 (mm)	S2 (mm)	Dynamic Pressure (x 1,000 PSI)
	1		2				
	(mm)	(in.)					
HDL4T-12M15PK	6	1/4	M12X1.5	21.5	33.0	14	6000
HDL4T-14M15PK	6	1/4	M14X1.5	23.5	35.5	17	6000
HDL6T-12M15PK	8,10	3/8	M12X1.5	25.0	35.5	17	6000
HDL6T-14M15PK	8,10	3/8	M14X1.5	25.0	35.5	17	6000
HDL6T-16M15PK	8,10	3/8	M16X1.5	25.0	37.5	17	6000
HDL8T-14M15PK	12	1/2	M14X1.5	28.0	36.0	19	6000
HDL8T-18M15PK	12	1/2	M18X1.5	28.0	41.0	19	6000
HDL8T-22M15PK	12	1/2	M22X1.5	31.0	49.0	27	6000
HDL10T-18M15PK	14,15,16	5/8	M18X1.5	33.5	47.5	27	6000
HDL10T-22M15PK	14,15,16	5/8	M22X1.5	33.5	49.0	27	6000
HDL12T-22M15PK	18,20	3/4	M22X1.5	37.5	49.0	27	6000
HDL12T-27M2PK	18,20	3/4	M27X2	37.5	55.5	27	6000
HDL16T-33M2PK	22,25	1	M33X2	41.5	59.5	36	5000
HDL20T-38M2PK	28,30,32	1 1/4	M38X2	44.5	62.0	41	4000
HDL20T-42M2PK	28,30,32	1 1/4	M42X2	44.5	63.0	41	4000
HDL24T-48M2PK	35,38	1 1/2	M48X2	49.0	71.5	50	4000

* For special M38x2 (ISO 6149-1 style) port. The current ISO 6149 does not include the M38 size.

HDLL-MPK

Long 90° Metric Straight Thread Elbow
ORFS-Long / ISO 6149

ISO 8434-3 SDEL
SAE 52M1587

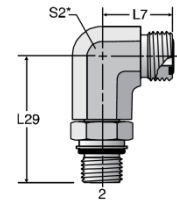

* S2 – Across Hex Flats

TUBE FITTING PART #	END SIZE			L7 (mm)	L29 (mm)	S2 (mm)	Dynamic Pressure (x 1,000 PSI)
	1		2				
	(mm)	(in.)	ISO 261				
HDLL4T-12M15PK	6	1/4	M12X1.5	21.5	56.5	14	6000
HDLL6T-14M15PK	8,10	3/8	M14X1.5	25.0	56.5	17	6000
HDLL6T-16M15PK	8,10	3/8	M16X1.5	25.0	66.5	17	6000
HDLL8T-18M15PK	12	1/2	M18X1.5	28.0	75.0	19	6000
HDLL8T-22M15PK	12	1/2	M22X1.5	31.5	88.0	27	6000
HDLL10T-22M15PK	14,15,16	5/8	M22X1.5	33.5	88.0	27	6000
HDLL12T-27M2PK	18,20	3/4	M27X2	37.5	100.5	27	6000
HDLL16T-33M2PK	22,25	1	M33X2	41.5	114.5	36	5000
HDLL20T-42M2PK	28,30,32	1 1/4	M42X2	44.5	126.5	41	4000

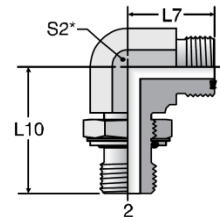

* S2 – Across Hex Flats

HDL-MP

Metric Straight Thread Elbow
ORFS / Metric - ORR

TUBE FITTING PART #	END SIZE			L7 (mm)	L10 (mm)	S2 (mm)	Dynamic Pressure (x 1,000 PSI)
	1		2				
	(mm)	(in.)	ISO 261				
HDL4T-12M15P	6	1/4	M12X1.5	21.5	33.0	14	3600
HDL6T-12M15P	8,10	3/8	M12X1.5	25.0	35.5	17	3600
HDL6T-14M15P	8,10	3/8	M14X1.5	25.0	35.5	17	3600
HDL6T-16M15P	8,10	3/8	M16X1.5	25.0	37.5	17	3600
HDL8T-14M15P	12	1/2	M14X1.5	28.0	36.0	19	3600
HDL8T-18M15P	12	1/2	M18X1.5	28.0	41.0	19	3600
HDL8T-22M15P	12	1/2	M22X1.5	31.5	49.0	27	3600
HDL10T-22M15P	14,15,16	5/8	M22X1.5	33.5	49.0	27	3600
HDL12T-27M2P	18,20	3/4	M27X2	37.5	55.5	30	3600
HDL16T-33M2P	22,25	1	M33X2	41.5	59.5	36	2500
HDL20T-38M2P	28,30,32	1 1/4	M38X2	44.5	62.0	41	2500
HDL20T-42M2P	28,30,32	1 1/4	M42X2	44.5	63.0	41	2500

HDL-GP

Male Elbow – BSPP
(for ISO 1179-1 Port)
ORFS / BSPP - ORR

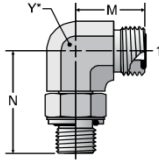

* Y – Across
Wrench Flats

TUBE FITTING PART #	END SIZE			M (mm)	N (mm)	Y (mm)	Dynamic Pressure (x 1,000 PSI)
	1		2				
	(mm)	(in.)					
HDL4T-2GP	6	1/4	1/8 - 28	21.5	30.0	14	4000
HDL4T-4GP	6	1/4	1/4 - 19	23.5	36.0	19	4000
HDL4T-6GP	6	1/4	3/8 - 19	24.5	38.0	19	4000
HDL6T-4GP	8,10	3/8	1/4 - 19	25.0	36.0	19	4000
HDL6T-6GP	8,10	3/8	3/8 - 19	26.5	38.0	19	4000
HDL8T-4GP	12	1/2	1/4 - 19	28.0	35.5	19	4000
HDL8T-6GP	12	1/2	3/8 - 19	28.0	38.0	19	4000
HDL8T-8GP	12	1/2	1/2 - 14	31.0	48.5	27	4000
HDL8T-12GP	12	1/2	3/4 - 14	33.5	51.5	30	4000
HDL10T-6GP	14,15,16	5/8	3/8 - 19	33.5	40.5	27	4000
HDL10T-8GP	14,15,16	5/8	1/2 - 14	33.5	48.5	27	4000
HDL10T-12GP	14,15,16	5/8	3/4 - 14	36.0	51.5	30	4000
HDL10T-16GP	14,15,16	5/8	1 - 11	39.5	58.5	36	4000
HDL12T-8GP	18,20	3/4	1/2 - 14	37.5	49.5	30	4000
HDL12T-12GP	18,20	3/4	3/4 - 14	37.5	51.5	30	4000
HDL12T-16GP	18,20	3/4	1 - 11	41.0	58.5	36	4000
HDL16T-12GP	22,25	1	3/4 - 14	41.5	56.0	36	4000
HDL16T-16GP	22,25	1	1 - 11	41.5	58.5	36	4000
HDL16T-20GP	22,25	1	1 1/4 - 11	44.5	61.0	41	3000
HDL20T-16GP	28,30,32	1 1/4	1 - 11	44.5	61.0	41	4000
HDL20T-20GP	28,30,32	1 1/4	1 1/4 - 11	44.5	61.0	41	2000
HDL20T-24GP	28,30,32	1 1/4	1 1/2 - 11	49.0	64.5	50	2000
HDL24T-24GP	35,38	1 1/2	1 1/2 - 11	49.0	64.5	50	2000

HDTBM

Bulkhead Branch Tee
ORFS (all three ends)

SAE 520959
WJLO-WLNL – Body with Locknut
(See page A11 for WLNL)

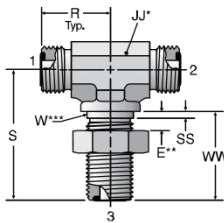

TUBE FITTING PART #	END SIZE		E MAX (in.)	JJ (in.)	R (mm)	S (mm)	SS (mm)	W DIA (mm)	WW (mm)	Dynamic Pressure (x 1,000 PSI)
	1-3 (in.)									
HDTBM-4T	1/4		13.97	9/16	22.61	46.99	1.52	14.22	31.50	9200
HDTBM-6T	3/8		13.97	3/4	25.91	52.07	1.52	17.53	34.04	9200
HDTBM-8T	1/2		13.97	3/4	28.96	55.63	1.52	20.57	36.58	9200
HDTBM-10T	5/8		13.97	1 1/16	34.54	62.99	1.52	25.40	40.39	6000
HDTBM-12T	3/4		13.97	1 3/16	38.61	67.06	1.52	30.23	41.40	6000
HDTBM-16T	1		13.97	1 7/16	42.42	71.12	1.52	36.58	41.91	6000

HDT

Union Tee
ORFS (all three ends)
SAE 520401

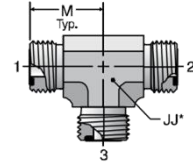

* JJ – Across
Wrench Flats

TUBE FITTING PART #	END SIZE		JJ (in.)	M (mm)	Dynamic Pressure (x 1,000 PSI)
	1-3 (in.)				
HDT-4T	1/4		9/16	21.59	9200
HDT-6T	3/8		3/4	24.89	9200
HDT-8T	1/2		3/4	27.94	9200
HDT-10T	5/8		1 1/16	33.53	6000
HDT-12T	3/4		1 3/16	37.59	6000
HDT-16T	1		1 7/16	41.40	6000
HDT-20T	1 1/4		1 5/8	44.45	5000
HDT-24T	1 1/2		1 7/8	49.02	4000
HDT-32T	2		2 1/2	70.10	3000

HDT

Union Tee – mm Hex
ORFS (all three ends)

ISO 8434-3 T
SAE 52M0401

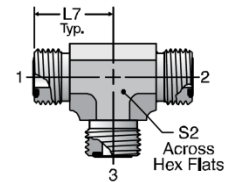

* S2 – Across
Hex Flats

TUBE FITTING PART #	END SIZE		L7 (mm)	S2 (mm)	Dynamic Pressure (x 1,000 PSI)
	1-3 (mm)	(in.)			
HDT-6M	6	1/4	21.5	14	9200
HDT-8M10M	8,10	3/8	25.0	19	9200
HDT-12M	12	1/2	28.0	19	9200
HDT-14M15M16M	14,15,16	5/8	33.5	27	6000
HDT-18M20M	18,20	3/4	37.5	30	6000
HDT-22M25M	22,25	1	41.5	36	6000
HDT-28M30M32M	28,30,32	1 1/4	44.5	41	5000
HDT-35M38M	35,38	1 1/2	49.0	50	4000

HDTBM

Bulkhead Union Tee – mm Hex
ORFS (all three ends)

ISO 8434-3 BHBT
SAE 52M0959
WJML OWLNML – Body with Locknut
(See page A11 for WLNML)

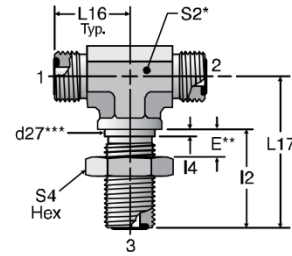

TUBE FITTING PART #	END SIZE		d27*** (mm)	E (mm)	I2 (mm)	I4 (mm)	L16 (mm)	L17 (mm)	S2 (mm)	S4 HEX (mm)	Dynamic Pressure (x 1,000 PSI)
	1-3										
	(mm)	(in.)									
HDTBM-6M	6	1/4	14.3	14	31.5	1.5	22.5	47.0	14	22	9200
HDTBM-8M10M	8,10	3/8	17.5	14	34.0	1.5	26.0	52.0	19	27	9200
HDTBM-12M	12	1/2	20.6	14	36.5	2.5	29.0	55.5	19	30	9200
HDTBM-14M15M16M	14,15,16	5/8	25.4	14	40.5	2.5	34.5	63.0	27	36	6000
HDTBM-18M20M	18,20	3/4	30.2	14	41.5	3.0	38.5	67.0	30	41	6000
HDTBM-22M25M	22,25	1	36.5	14	42.0	3.0	42.5	71.0	36	46	6000
HDTBM-28M30M32M	28,30,32	1 1/4	42.9	14	42.0	3.0	45.5	75.5	41	50	5000
HDTBM-35M38M	35,38	1 1/2	50.8	14	42.0	3.0	49.5	79.5	50	60	4000

*S2 –Across wrench flats.

**E-Maximum bulkhead thickness.

***d27-Bulkhead pilot diameter. Recommended hole is d27 + 0.4mm.

HDTRM

Bulkhead Run Tee
ORFS (all three ends)

SAE 520958
WJJLOWLNML – Body with Locknut
(See page A11 for WLNML)

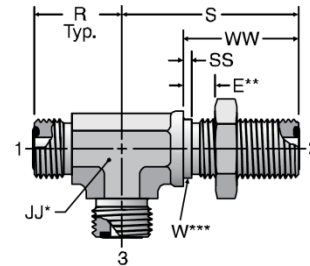

TUBE FITTING PART #	END SIZE		E MAX (mm)	JJ (in.)	R (mm)	S (mm)	SS (mm)	W DIA (mm)	WW (mm)	Dynamic Pressure (x 1,000 PSI)
	1-3									
	(in.)									
HDTRM-4T	1/4		13.97	9/16	22.61	46.99	1.52	14.22	31.50	9200
HDTRM-6T	3/8		13.97	3/4	25.91	52.07	1.52	17.53	34.04	9200
HDTRM-8T	1/2		13.97	3/4	28.96	55.63	1.52	20.57	36.58	9200
HDTRM-10T	5/8		13.97	1 1/16	34.54	62.99	1.52	25.40	40.39	6000
HDTRM-12T	3/4		13.97	1 3/16	38.61	67.06	1.52	30.23	41.40	6000
HDTRM-16T	1		13.97	1 7/16	42.42	71.12	1.52	36.58	41.91	6000
HDTRM-20T	1 1/4		13.97	1 5/8	45.47	70.87	1.52	42.93	41.91	5000
HDTRM-24T	1 1/2		13.97	1 7/8	49.53	79.50	1.52	50.80	41.91	4000

*JJ –Across wrench flats.

**E-Maximum bulkhead thickness.

***W-Bulkhead pilot diameter. Recommended clearance hole is W + 0.015”.

HDTRM

Bulkhead Run Tee – mm Hex
ORFS (all three ends)

ISO 8434-3 BHRT
SAE 52M0958
WJJMLOWLNML – Body with Locknut
(See page A11 for WLNML)

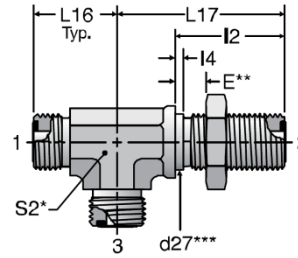

TUBE FITTING PART #	END SIZE		d27*** (mm)	E (mm)	I2 (mm)	I4 (mm)	L16 (mm)	L17 (mm)	S2 (mm)	Dynamic Pressure (x 1,000 P SI)
	1-3									
	(mm)	(in.)								
HDTRM-6M	6	1/4	14.3	14	31.5	1.5	22.5	47.0	14	9200
HDTRM-8M10M	8,10	3/8	17.5	14	34.0	1.5	26.0	52.0	19	9200
HDTRM-12M	12	1/2	20.6	14	36.5	2.5	29.0	55.5	19	9200
HDTRM-14M15M16M	14,15,16	5/8	25.4	14	40.5	2.5	34.5	63.0	27	6000
HDTRM-18M20M	18,20	3/4	30.2	14	41.5	3.0	38.5	67.0	30	6000
HDTRM-22M25M	22,25	1	36.5	14	42.0	3.0	42.5	71.0	36	6000
HDTRM-28M30M32M	28,30,32	1 1/4	42.9	14	42.0	3.0	45.5	71.0	41	5000
HDTRM-35M38M	35,38	1 1/2	50.8	14	42.0	3.0	49.5	79.5	50	4000

*S2 –Across wrench flats.

**E-Maximum bulkhead thickness.

***d27-Bulkhead pilot diameter. Recommended hole is d27 + 0.4mm.

HDTBSV

Swivel Nut Branch Tee
ORFS / ORFS / ORFS Swivel

SAE 520433

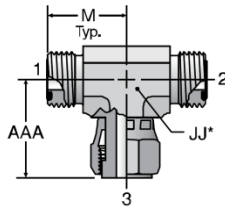

* JJ – Across Wrench Flats

TUBE FITTING PART #	END SIZE		AAA (mm)	JJ (in.)	M (mm)	Dynamic Pressure (x 1,000 PSI)
	1-3					
	(in.)	(mm)				
HDTBSV-4T	1/4	27.18	9/16	21.59	9200	
HDTBSV-6T	3/8	29.72	3/4	24.89	9200	
HDTBSV-8T	1/2	38.10	3/4	27.94	9200	
HDTBSV-10T	5/8	40.89	1 1/16	33.53	6000	
HDTBSV-12T	3/4	46.48	1 3/16	37.59	6000	
HDTBSV-16T	1	53.59	1 7/16	41.40	6000	
HDTBSV-20T	1 1/4	57.91	1 5/8	44.45	5000	
HDTBSV-24T	1 1/2	60.96	1 7/8	49.02	4000	

HDTBSV

Swivel Nut Branch Tee – mm Hex
ORFS / ORFS / ORFS Swivel

ISO 8434-3 SWBT
SAE 52M0433

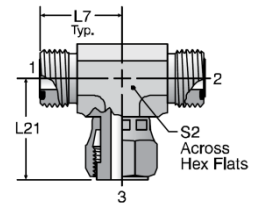

* S2 – Across Wrench Flats

TUBE FITTING PART #	END SIZE		L7 (mm)	L21 (mm)	S2 (mm)	Dynamic Pressure (x 1,000 PSI)
	1-3					
	(mm)	(in.)				
HDTBSV-6M	6	1/4	21.5	27.2	14	9200
HDTBSV-8M10M	8,10	3/8	25.0	29.7	19	9200
HDTBSV-12M	12	1/2	28.0	38.0	19	9200
HDTBSV-14M15M16M	14,15,16	5/8	33.5	41.0	27	6000
HDTBSV-18M20M	18,20	3/4	37.5	46.5	30	6000
HDTBSV-22M25M	22,25	1	41.5	53.5	36	6000
HDTBSV-28M30M32M	28,30,32	1 1/4	44.5	58.0	41	4000
HDTBSV-35M38M	35,38	1 1/2	49.0	61.0	50	4000

HDTRSV

Swivel Nut Run Tee
ORFS / ORFS Swivel / ORFS

SAE 520432

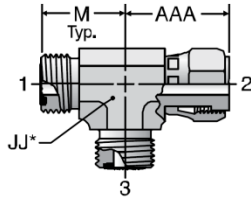

* JJ – Across
Wrench Flats

TUBE FITTING PART #	END SIZE		JJ (in.)	M (mm)	Dynamic Pressure (x 1,000 PSI)
	1-3 (in.)	AAA (mm)			
HDTRSV-4T	1/4	27.18	9/16	21.59	9200
HDTRSV-6T	3/8	29.72	3/4	24.89	9200
HDTRSV-8T	1/2	38.10	3/4	27.94	9200
HDTRSV-10T	5/8	40.89	1 1/16	33.53	6000
HDTRSV-12T	3/4	46.48	1 3/16	37.59	6000
HDTRSV-16T	1	53.59	1 7/16	41.40	6000
HDTRSV-20T	1 1/4	57.91	1 5/8	44.45	5000
HDTRSV-24T	1 1/2	60.96	1 7/8	49.02	4000

HDTRSV

Swivel Nut Run Tee – mm Hex
ORFS / ORFS Swivel / ORFS

ISO 8434-3 SWE
SAE 52M0432

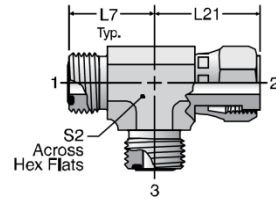

TUBE FITTING PART #	END SIZE					Dynamic Pressure (x 1,000 PSI)
	1 (mm)	2 (in.)	L7 (mm)	L21 (mm)	S2 (mm)	
HDTRSV-6M	6	1/4	21.5	27.2	14	9200
HDTRSV-8M10M	8,10	3/8	25.0	29.7	19	9200
HDTRSV-12M	12	1/2	28.0	38.0	19	9200
HDTRSV-14M15M16M	14,15,16	5/8	33.5	41.0	27	6000
HDTRSV-18M20M	18,20	3/4	37.5	46.5	30	6000
HDTRSV-22M25M	22,25	1	41.6	53.5	36	6000
HDTRSV-28M30M32M	28,30,32	1 1/4	44.5	58.0	41	4000
HDTRSV-35M38M	35,38	1 1/2	48.8	61.0	50	4000

HDTBM-UP

Straight Thread Branch Tee
ORFS / ORFS / SAE - ORB

SAE 520429

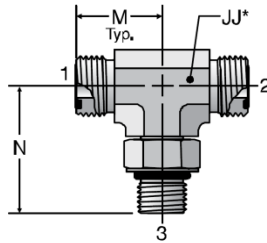

* JJ – Across
Wrench Flats

TUBE FITTING PART #	END SIZE			JJ (in.)	M (mm)	N (mm)	Dynamic Pressure (x 1,000 PSI)
	1 (in.)	2 (in.)	3 UN/UNF-2A				
HDTBM4T-4UP	1/4	1/4	7/16 - 20	9/16	21.59	33.02	6000
HDTBM4T-6UP	1/4	1/4	9/16 - 18	9/16	23.62	37.08	6000
HDTBM6T-6UP	3/8	3/8	9/16 - 18	3/4	24.89	37.08	6000
HDTBM6T-4UP	3/8	3/8	7/16 - 20	3/4	24.89	35.05	6000
HDTBM6T-8UP	3/8	3/8	3/4 - 16	3/4	26.42	40.39	6000
HDTBM8T-8UP	1/2	1/2	3/4 - 16	3/4	27.94	40.39	6000
HDTBM8T-10UP	1/2	1/2	7/8 - 14	1 1/16	31.50	50.04	6000
HDTBM8T-12UP	1/2	1/2	1 1/16 - 12	1 3/16	34.04	55.12	6000
HDTBM10T-10UP	5/8	5/8	7/8 - 14	1 1/16	33.53	50.04	6000
HDTBM10T-12UP	5/8	5/8	1 1/16 - 12	1 3/16	36.07	55.12	6000
HDTBM12T-12UP	3/4	3/4	1 1/16 - 12	1 3/16	37.59	55.12	6000
HDTBM12T-16UP	3/4	3/4	1 5/16 - 12	1 7/16	40.89	59.44	5500
HDTBM16T-16UP	1	1	1 5/16 - 12	1 7/16	41.40	59.44	5500
HDTBM16T-20UP	1	1	1 5/8 - 12	1 5/8	44.45	61.98	4000
HDTBM20T-20UP	1 1/4	1 1/4	1 5/8 - 12	1 5/8	44.45	61.98	4000
HDTBM24T-24UP	1 1/2	1 1/2	1 7/8 - 12	1 7/8	49.02	66.04	4000

HDTRM-UP

Straight Thread Run Tee
ORFS / SAE-ORB / ORFS

SAE 520428

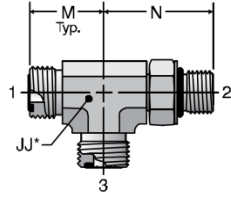

* JJ – Across
Wrench Flats

HDTBM

Male Pipe Tee
ORFS / ORFS / NPTF

SAE 520425

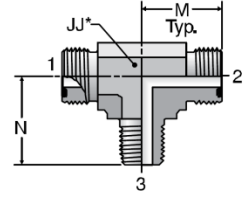

* JJ – Across
Wrench Flats

TUBE FITTING PART #	END SIZE			JJ (in.)	M (mm)	N (mm)	Dynamic Pressure (x 1,000 PSI)
	1 (in.)	2 UN/UNF-2A	3 (in.)				
HDTRM4T-4UP	1/4	7/16 - 20	1/4	9/16	21.59	33.02	6000
HDTRM4T-6UP	1/4	9/16 - 18	1/4	3/4	23.37	37.08	6000
HDTRM6T-6UP	3/8	9/16 - 18	3/8	3/4	24.89	37.08	6000
HDTRM6T-8UP	3/8	3/4 - 16	3/8	3/4	26.42	40.39	6000
HDTRM8T-8UP	1/2	3/4 - 16	1/2	3/4	27.94	40.39	6000
HDTRM8T-10UP	1/2	7/8 - 14	1/2	1 1/16	31.50	50.04	6000
HDTRM10T-10UP	5/8	7/8 - 14	5/8	1 1/16	33.53	50.04	6000
HDTRM10T-12UP	5/8	1 1/16 - 12	5/8	1 3/16	36.07	55.12	6000
HDTRM12T-12UP	3/4	1 1/16 - 12	3/4	1 3/16	37.59	55.12	6000
HDTRM12T-16UP	3/4	1 5/16 - 12	3/4	1 7/16	40.89	59.44	5500
HDTRM16T-16UP	1	1 5/16 - 12	1	1 7/16	41.40	59.44	5500
HDTRM16T-20UP	1	1 5/8 - 12	1	1 5/8	44.45	61.98	4000
HDTRM20T-20UP	1 1/4	1 5/8 - 12	1 1/4	1 5/8	44.45	61.98	4000
HDTRM24T-24UP	1 1/2	1 7/8 - 12	1 1/2	1 7/8	49.02	66.04	4000

TUBE FITTING PART #	END SIZE		JJ (in.)	M (mm)	N (mm)	Dynamic Pressure (x 1,000 PSI)
	1 & 2 (in.)	3 NPTF				
HDTBM4T-4N	1/4	1/4 - 18	9/16	21.59	28.45	6000
HDTBM6T-4N	3/8	1/4 - 18	3/4	24.89	27.69	6000
HDTBM6T-6N	3/8	3/8 - 18	3/4	24.89	30.99	6000
HDTBM8T-6N	1/2	3/8 - 18	3/4	27.94	30.99	6000
HDTBM8T-8N	1/2	1/2 - 14	7/8	27.94	37.34	6000
HDTBM10T-8N	5/8	1/2 - 14	1 1/16	33.27	37.34	6000
HDTBM12T-12N	3/4	3/4 - 14	1 3/16	37.34	40.39	4000
HDTBM16T-16N	1	1 - 11 1/2	1 7/16	41.66	50.04	3000
HDTBM20T-20N	1 1/4	1 1/4 - 11 1/2	1 5/8	44.70	60.45	2500

HDTBM-MP

Metric Straight Thread Branch Tee
ORFS / ORFS / ISO 6149

ISO 8434-3 SDBT
SAE 52M0489

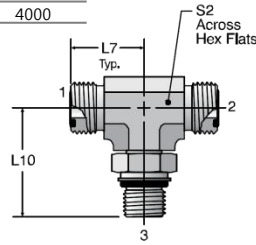

* S2 – Across
Hex Flats

TUBE FITTING PART #	END SIZE			L7 (mm)	L10 (mm)	S2 (mm)	Dynamic Pressure (x 1,000 PSI)
	1 & 2 (mm)	3 (in.)	ISO 261				
HDTBM4T-12M15P	6	1/4	M12X1.5	21.5	33.0	14	6000
HDTBM4T-14M15P	6	1/4	M14X1.5	23.5	35.5	19	6000
HDTBM6T-14M15P	8,10	3/8	M14X1.5	25.0	35.5	19	6000
HDTBM6T-16M15P	8,10	3/8	M16X1.5	25.0	37.5	19	6000
HDTBM8T-14M15P	12	1/2	M14X1.5	28.0	36.0	19	6000
HDTBM8T-18M15P	12	1/2	M18X1.5	28.0	41.0	19	6000
HDTBM8T-22M15P	12	1/2	M22X1.5	31.0	49.0	27	6000
HDTBM10T-22M15P	14,15,16	5/8	M22X1.5	33.5	49.0	27	6000
HDTBM12T-27M2P	18,20	3/4	M27X2	37.5	55.5	30	6000
HDTBM16T-33M2P	22,25	1	M33X2	41.5	59.5	36	5100
HDTBM20T-42M2P	28,30,32	1 1/4	M42X2	44.5	63.0	41	4000
HDTBM24T-48M2P	35,38	1 1/2	M48X2	49.0	71.5	50	4000

HDTRM-MP

Metric Straight Thread Run Tee
ORFS / ISO 6149 / ORFS

ISO 8434-3 SDRT
SAE 52M0488

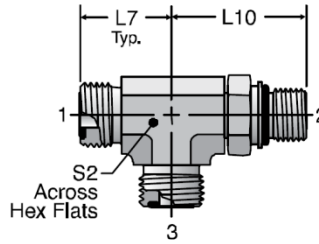

TUBE FITTING PART #	END SIZE			L7 (mm)	L10 (mm)	S2 (mm)	Dynamic Pressure (x 1,000 PSI)
	1 & 3		2 ISO 261				
	(mm)	(in.)					
HDTBM4T-12M15P	6	1/4	M12X1.5	21.5	33.0	14	6000
HDTBM4T-14M15P	6	1/4	M14X1.5	23.5	35.5	19	6000
HDTBM6T-14M15P	8,10	3/8	M14X1.5	25.0	35.5	19	6000
HDTBM6T-16M15P	8,10	3/8	M16X1.5	25.0	37.5	19	6000
HDTBM8T-14M15P	12	1/2	M14X1.5	28.0	36.0	19	6000
HDTBM8T-18M15P	12	1/2	M18X1.5	28.0	41.0	19	6000
HDTBM8T-22M15P	12	1/2	M22X1.5	31.0	49.0	27	6000
HDTBM10T-22M15P	14,15,16	5/8	M22X1.5	33.5	49.0	27	6000
HDTBM12T-27M2P	18,20	3/4	M27X2	37.5	55.5	30	6000
HDTBM16T-32M2P	22,25	1	M32X2	41.5	59.5	36	4000
HDTBM20T-42M2P	28,30,32	1 1/4	M42X2	44.5	63.0	41	4000
HDTBM24T-48M2P	35,38	1 1/2	M48X2	49.0	71.5	50	4000

HDTBM-GP

Branch Tee – BSPP
(for ISO 1179-1 Port)
ORFS / ORFS / BSPP - ORR

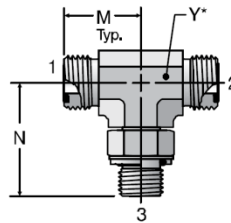

* Y – Across Wrench Flats

TUBE FITTING PART #	END SIZE			M (mm)	N (mm)	Y (mm)	Dynamic Pressure (x 1,000 PSI)
	1 & 2		3 BSPP				
	(mm)	(in.)					
HDTBM4T-2GP	6	1/4	1/8 - 28	21.5	30.0	14	4000
HDTBM4T-4GP	6	1/4	1/4 - 19	23.5	36.0	19	4000
HDTBM6T-4GP	8,10	3/8	1/4 - 19	25.0	36.0	19	4000
HDTBM6T-6GP	8,10	3/8	3/8 - 19	26.5	38.0	19	4000
HDTBM8T-6GP	12	1/2	3/8 - 19	28.0	38.0	19	4000
HDTBM8T-8GP	12	1/2	1/2 - 14	31.0	48.5	27	4000
HDTBM10T-8GP	14,15,16	5/8	1/2 - 14	33.5	48.5	27	4000
HDTBM12T-12GP	18,20	3/4	3/4 - 14	37.5	51.5	30	4000
HDTBM16T-16GP	22,25	1	1 - 11	41.5	58.5	36	4000

HDTRM-GP

Run Tee – BSPP
(for ISO 1179-1 Port)
ORFS / BSPP-ORR / ORFS

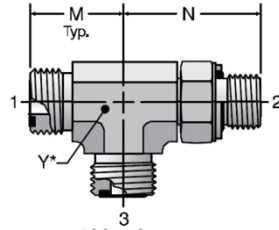

* Y – Across
Wrench Flats

TUBE FITTING PART #	END SIZE			M (mm)	N (mm)	Y (mm)	Dynamic Pressure (x 1,000 PSI)
	1 & 3		2				
	(mm)	(in.)	BSPP				
HDTRM4T-2GP	6	1/4	1/8 - 28	21.5	30.0	14	4000
HDTRM4T-4GP	6	1/4	1/4 - 19	23.5	36.0	19	4000
HDTRM6T-4GP	8,10	3/8	1/4 - 19	25.0	36.0	19	4000
HDTRM6T-6GP	8,10	3/8	3/8 - 19	26.5	38.0	19	4000
HDTRM8T-6GP	12	1/2	3/8 - 19	28.0	38.0	19	4000
HDTRM8T-8GP	12	1/2	1/2 - 14	31.0	48.5	27	4000
HDTRM10T-8GP	14,15,16	5/8	1/2 - 14	33.5	45.2	27	4000
HDTRM12T-12GP	18,20	3/4	3/4 - 14	37.5	51.5	30	4000
HDTRM16T-16GP	22,25	1	1 - 11	41.5	58.5	37	4000

HDX

Union Cross
ORFS (all four ends)

SAE 520501

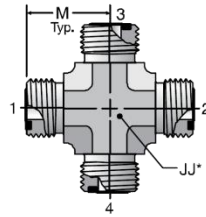

* JJ – Across
Wrench Flats

TUBE FITTING PART #	END SIZE		M (mm)	Dynamic Pressure (x 1,000 PSI)
	1 - 4 (in.)	JJ (in.)		
HDX-4T	1/4	9/16	21.59	9200
HDX-6T	3/8	3/4	24.89	9200
HDX-8T	1/2	3/4	27.94	9200
HDX-10T	5/8	1 1/16	33.53	6000
HDX-12T	3/4	1 3/16	37.59	6000
HDX-16T	1	1 7/16	41.40	6000
HDX-20T	1 1/4	1 5/8	44.45	5000

HDP

Plug
ORFS

SAE 520109

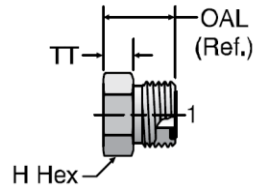

TUBE FITTING PART #	END SIZE		OAL (REF) (mm)	TT (mm)	Dynamic Pressure (x 1,000 PSI)
	1 (in.)	H HEX (in.)			
HDP-4T	1/4	5/8	16.51	5.08	9200
HDP-6T	3/8	3/4	19.05	8.13	9200
HDP-8T	1/2	7/8	22.10	8.89	9200
HDP-10T	5/8	1 1/16	25.91	10.41	6000
HDP-12T	3/4	1 1/4	27.43	10.41	6000
HDP-14T	7/8	1 3/8	27.94	12.45	6000
HDP-16T	1	1 1/2	27.94	10.41	6000
HDP-20T	1 1/4	1 3/4	27.94	10.41	6000
HDP-24T	1 1/2	2 1/8	27.94	10.41	5000
HDP-32T	2	2 3/4	35.56	12.70	3000

HDP

Plug – mm Hex
ORFS

ISO 8434-3 PL
SAE 52M0109

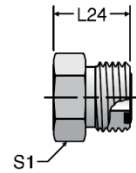

TUBE FITTING PART #	ORFS TUBE O.D.		L24 (mm)	S1 HEX (mm)	Dynamic Pressure (x 1,000 PSI)
	(mm)	(in.)			
HDP-6M	6	1/4	16.5	17	9200
HDP-8M10M	8,10	3/8	19.0	19	9200
HDP-12M	12	1/2	22.0	22	9200
HDP-14M15M16M	14,15,16	5/8	26.0	27	6000
HDP-18M20M	18,20	3/4	27.5	32	6000
HDP-22M25M	22,25	1	28.0	41	6000
HDP-28M30M32M	28,30,32	1 1/4	28.0	46	6000
HDP-38M	38	1 1/2	28.0	55	5000

HDC

Cap
ORFS

SAE 520112

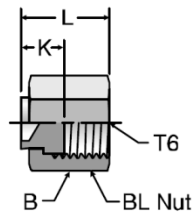

TUBE FITTING PART #	TUBE O.D. (in.)	T6 SWIVEL UN/UNF - 2B	B HEX (in.)	K (mm)	L (mm)	Dynamic Pressure (x 1,000 PSI)
HDC-4T	1/4	9/16 - 18	11/16	8.89	16.76	9200
HDC-6T	3/8	11/16 - 16	13/16	10.41	18.80	9200
HDC-8T	1/2	13/16 - 16	15/16	11.94	22.10	9200
HDC-10T	5/8	1 - 14	1 1/8	13.46	25.91	6000
HDC-12T	3/4	1 3/16 - 12	1 3/8	14.99	28.45	6000
HDC-14T	7/8	1 5/16 - 12	1 1/2	14.99	28.45	6000
HDC-16T	1	1 7/16 - 12	1 5/8	16.00	29.46	6000
HDC-20T	1 1/4	1 11/16 - 12	1 7/8	16.00	29.46	6000
HDC-24T	1 1/2	2 - 12	2 1/4	16.00	29.46	5000
HDC-32T	2	2 1/2 - 12	2 7/8	20.07	37.08	3000

HDC

Cap
ORFS

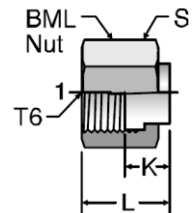

TUBE FITTING PART #	TUBE O.D.		T6 SWIVEL UN/UNF-2B	K (mm)	L (mm)	S HEX (mm)	Dynamic Pressure (x 1,000 PSI)
	(mm)	(in.)					
HDC-6M	6	1/4	9/16 - 18	9.0	16.8	17	9200
HDC-8M10M	8,10	3/8	11/16 - 16	10.5	18.8	22	9200
HDC-12M	12	1/2	13/16 - 16	12.0	22.0	24	9200
HDC-14M15M16M	14,15,16	5/8	1 - 14	13.5	26.0	30	6000
HDC-18M20M	18,20	3/4	1 3/16 - 12	15.0	28.6	36	6000
HDC-22M25M	22,25	1	1 7/16 - 12	16.0	29.5	41	6000
HDC-28M30M32M	28,30,32	1 1/4	1 11/16 - 12	16.0	29.5	50	6000
HDC-35M38M	35,38	1 1/2	2 - 12	16.0	29.5	60	5000

HDUPTC

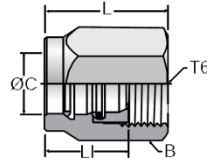

TUBE FITTING PART #	END SIZE (in.)	T6 UN/UNF - 2B	B HEX (in.)	L (mm)	L1 (mm)	C	
						Nominal Nipple Size	
						(in.)	(mm)
HDUPTC-4T	1/4	9/16 - 18	11/16	24.64	17.27	7.87	8
HDUPTC-6T	3/8	11/16 - 16	13/16	26.92	18.80	11.94	12
HDUPTC-8T	1/2	13/16 - 16	15/16	30.23	20.57	14.99	15
HDUPTC-10T	5/8	1 - 14	1 1/8	34.04	22.10	18.03	18
HDUPTC-12T	3/4	1 3/16 - 12	1 3/8	35.05	21.84	22.10	22
HDUPTC-16T	1	1 7/16 - 12	1 5/8	37.59	23.88	24.89	25

To order as pre-torqued assembly on standard Seal-Lok adapters, see page A7.

