

IDK-LOK

Fittings & Valves

Instrumentation Pipe & Weld Fittings

No.03-8
July 2013



Thread Fittings

Close Nipple
GNC



04

Hex Nipple
GNH



04

Hex Reducing Nipple
GNR



05

Hex Nipple
GNH



05

Hex Nipple
GNH



05

Hex Long Nipple
GNL



05

Adapter
GAAMF



06

Reducing Adapter
GABMF



06

Adapter
GACMF



06

Adapter
GADMF



06

Reducing Hex Bushing
GHB



07

Pipe Cap
GC



07

Pipe Plug



07

GP

Hex Coupling



08

GCG

Hex Reducing Coupling



08

GCGR

Union Ball Joint



08

GJU

ISO Parallel Copper



08

GASKET DGC

Hollow Hex Plug



08

GPA

Hollow Hex Plug



08

GPB

Snubber Fitting



09

GS

Elbow



09

GL

Street Elbow



09

GLS

Reducing Street Elbow



10

GLSR

Male Elbow



10

GLM

Tee



10

GT

Run Tee



10

GTR

Branch Tee



11

GTB

Male Tee



11























GTM

Cross



11

GX

10K Thread Fittings			Thread Fittings for Over 1"			Weld Fittings		
Elbow GL-10K		12	Elbow GL-6K		15	Union GUSW		16
Tee GT-10K		12	Tee GT-6K		15	Union Elbow GLSW		16
Cross GX-10K		13	Hex Coupling GCG-6K		15	Union Tee GTSW		16
Hex Nipple GNH-10K		13	Hex Coupling GNH-6K		15	Male Connector GCMSW		16
Hex Coupling GCG-10K		13	Cross GX-6K		15	Female Connector GCFSW		17
Male Adapter GAAMF-10K		13				Male Elbow GLMSW		17
Reducing Adapter GABMF-10K		14				Female Elbow GLFSW		17
Reducing Adapter GAMF-10K		14				Pipe To Tube Socket Weld GUWSW		17
						Tube To Tube Socket Weld GUTWSW		18



DK-Lok Thread Fittings

Three different ratings are available to fit your specific application.

- Standard rating : page 3
- 10,000 psig : page 12
- 6,000 psig : page 15

DK-Lok Weld Fittings

See page 16

- Tube Socket Weld
- Pipe Butt-weld

Features of DK-Lok Thread Fittings

- Wrench flat body design allowing standard Hex. wrench assembly.
- Attractive finishes to suit precision equipment.
- Much less-weight design compared to Class 3000 pipe fittings.
- Fine pipe thread construction equals or exceeds the requirement of ASME B1.20.1 to ensure maximum thread engagement.
- Male pipe threads capped for protection from damages.
- Fitting materials available in SS316, Brass and Carbon Steel.

Thread Fittings - Standard Rating

DK-Lok Thread Fittings - Standard Rating are designed to the requirements of ASME B31.3 process piping code. The pipe thread sizes are available 1/8" to 1"

Table 1. **Pressure Ratings**

Size Designator	NPT/ISO Pipe Size	Stainless Steel 316				Brass				Carbon Steel			
		Male		Female		Male		Female		Male		Female	
		bar	psig	bar	psig	bar	psig	bar	psig	bar	psig	bar	psig
2	1/8	689	10,000	420	6,100	337	4,900	207	3,000	689	10,000	420	6,100
4	1/4	558	8,100	434	6,300	275	4,000	214	3,200	558	8,100	434	6,300
6	3/8	524	7,600	345	5,000	262	3,800	172	2,500	524	7,600	345	5,000
8	1/2	517	7,500	324	4,700	255	3,700	158	2,300	517	7,500	324	4,700
12	3/4	496	7,200	303	4,400	248	3,600	152	2,200	496	7,200	303	4,400
16	1	365	5,300	296	4,300	172	2,500	145	2,100	365	5,300	296	4,300

- Pressure ratings listed are for temperature up to 37°C (100°F)
- Pressure rating is calculated at -28 to 37°C (-20 to 100°F) using allowable stress value of 20,000psi for SS316, 10,000psi for Brass, and 20,000psi for Carbon Steel as per ASME B31.3 Process Piping Code.
- To determine the working pressure of ASME B31.1 Power Piping Code, multiply the ASME B31.3 rating by 0.94. Brass pressure ratings remain the same.
- The pressure ratings of reducing hex bushing (GHB), pipe plug (GP), and shaped fittings such as Elbow, Tee, Crosses are not covered in this table. See the pressure rating in the dimensional table.

Table 2. Material Standards and Temperature Range

Materials	Bar Stock	Forgings	Maximum Temperature
Stainless Steel 316	ASTM A276 Type 316 / ASTM A479 Type 316	ASTM A182 F316	537°C (1000°F)
Brass	JIS H3250 C3604 / ASTM B453 C35300	JIS H3250 C3771 / ASTM B283 C37700	204 °C (400°F)
Carbon Steel	ASTM A108 / JIS G4051 S20C - S48C	ASTM A105 / JIS G4051 S20C - S48C	190 °C (375 °F)

Table 3. Temperature De-rating Factors

Temp.	°F	100	200	300	400	500	600	700	800	900	1,000	1,200
	°C	38	93	149	204	260	316	371	427	482	538	649
Factor	Stainless Steel	1.00	1.00	1.00	0.97	0.90	0.85	0.82	0.80	0.78	0.77	0.49
	Brass	1.00	0.78	0.69	0.13							
	Carbon Steel	1.00	0.94	0.91	0.88							

To determine the allowable working pressure at a specific temperature, multiply the working pressure by the applicable factor shown in table 3. Example: The working pressure of GNC-2N-S at 700 °F. 10 000 psig x 0.82 = 8200 psig.

Table 4. Temperature Ratings of O-ring, Gasket Materials

System temperature may be limited by the O-ring, Gasket material or thread sealant.

Component	Applicable Part #	Material	Temperature Ratings
O-ring	Designator : BN	NBR	-20 to 105°C (-4 to 221°F)
	Designator : VT	FKM	-28 to 204°C (-18 to 400°F)
	Designator : KZ	FFKM	-30 to 275°C (-22 to 527°F)
Copper Gasket	DGC-	Copper	-198 to 204°C (-324 to 400°F)
NBR bonded Gasket	DGB-	NBR bonded Carbon Steel Ring	-40 to 110°C (-40 to 230°F)
FKM bonded Gasket	DGV-	FKM bonded bonded Stainless Steel Ring	-28 to 204°C (-20 to 400°F)

Table 5. Pipe Thread Designator

Designator	Pipe	NPT ASME B1.20.1	ISO Thread	
			Tapered ISO 7-1	Parallel ISO 228-1
2	1/8	2N	2R	2G
4	1/4	4N	4R	4G
6	3/8	6N	6R	6G
8	1/2	8N	8R	8G
12	3/4	12N	12R	12G
16	1	16N	16R	16G

How to order

Select the desired fitting basic part number, and add a material designator below. Example: GL-2N-S

Material	SS 316 / 316L Dual Grade	Carbon Steel	Brass
Material Designator	S	C	B

CLOSE NIPPLE

GNC Male NPT both ends

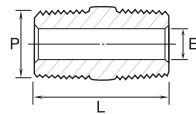

Part Number	P NPT in.	L mm	E mm
GNC- 2N	1/8	19.05	4.8
GNC- 4N	1/4	28.4	7.1
GNC- 6N	3/8	28.4	9.6
GNC- 8N	1/2	38.1	11.9
GNC-12N	3/4	38.1	15.7
GNC-16N	1	47.8	22.4

HEX NIPPLE

GNH Male NPT both ends

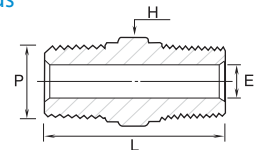

Part Number	P NPT in.	L mm	E mm	H Hex mm
GNH- 2N	1/8	25.65	4.8	11.1
GNH- 4N	1/4	35.56	7.1	14.2
GNH- 6N	3/8	36.32	9.6	17.4
GNH- 8N	1/2	46.73	11.9	22.2
GNH-12N	3/4	46.73	15.7	26.9
GNH-16N	1	58.92	22.3	34.9

HEX REDUCING NIPPLE

GNR Male NPT to reduced male NPT

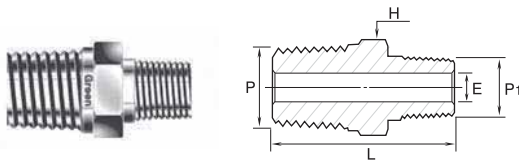

Part Number	P NPT in.	P1 Reduced NPT in.	L mm	E mm	H Hex mm
GNR 4-2N	1/4	1/8	30.7	4.8	14.2
GNR 6-2N	3/8	1/8	32.0	4.8	17.4
GNR 6-4N	3/8	1/4	36.1	7.1	17.4
GNR 8-2N	1/2	1/8	37.2	4.8	22.2
GNR 8-4N	1/2	1/4	41.7	7.1	22.2
GNR 8-6N	1/2	3/8	41.7	9.6	22.2
GNR 12-4N	3/4	1/4	41.7	7.1	26.9
GNR 12-8N	3/4	1/2	46.7	11.9	26.9
GNR 16-4N	1	1/4	49.3	7.1	34.9
GNR 16-8N	1	1/2	54.1	11.9	34.9

HEX NIPPLE

GNH Male NPT to ISO tapered

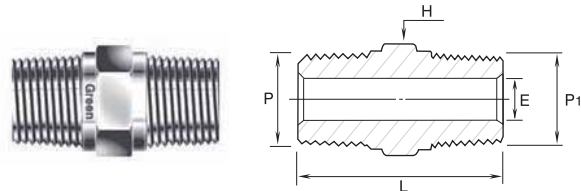

Part Number	P NPT in.	P1 ISO Thread Size	L mm	E mm	H Hex mm
GNH- 2NR	1/8	1/8-28 (7-1)	24.6	4.8	11.1
GNH- 4NR	1/4	1/4-19 (7-1)	35.6	7.1	14.2
GNH- 6NR	3/8	3/8-19 (7-1)	36.3	9.6	17.4
GNH- 8NR	1/2	1/2-14 (7-1)	46.7	11.9	22.2
GNH-12NR	3/4	3/4-14 (7-1)	46.7	15.7	26.9
GNH-16NR	1	1-11 (7-1)	58.9	22.4	34.9

HEX NIPPLE

GNH Male NPT to male ISO parallel

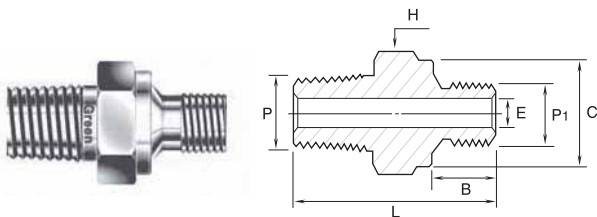

Part Number	P NPT in.	P1 ISO Thread Size	L mm	B mm	C mm	E mm	H Hex mm
GNH- 2NG	1/8	1/8-28 (228-1)	27.4	7.1	13.7	4.1	14.2
GNH- 4NG	1/4	1/4-19 (228-1)	36.8	11.2	17.8	5.8	19.05
GNH- 6NG	3/8	3/8-19 (228-1)	37.6	11.2	21.8	7.9	22.2
GNH- 8NG	1/2	1/2-14 (228-1)	45.0	14.2	26.1	11.9	26.9
GNH-12NG	3/4	3/4-14 (228-1)	49.0	15.7	31.5	15.7	33.3
GNH-16NG	1	1-11 (228-1)	56.9	18.3	38.9	19.8	41

HEX LONG NIPPLE

GNL Male NPT both ends

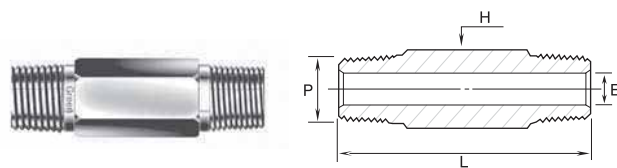

Part Number	P NPT in.	L mm	E mm	H Hex mm
GNL- 2N	1/8	★	4.8	11.1
GNL- 4N	1/4	★	7.1	14.2
GNL- 6N	3/8	★	9.7	17.4
GNL- 8N	1/2	★	11.9	22.2
GNL-12N	3/4	★	15.7	26.9
GNL-16N	1	★	22.4	34.9

ADAPTER

GAAMF Male NPT to equal female NPT

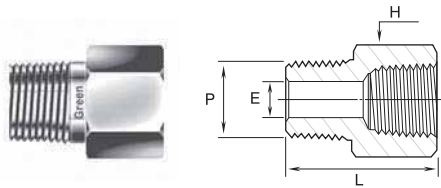

Part Number	P NPT in.	L mm	E mm	H Hex mm
GAAMF-2N	1/8	27.94	4.8	14.2
GAAMF-4N	1/4	35.56	7.1	19.05
GAAMF-6N	3/8	38.35	9.6	22.2
GAAMF-8N	1/2	49.27	11.9	26.9
GAAMF-12N	3/4	51.3	15.7	33.3
GAAMF-16N	1	57.91	22.3	41.2

REDUCING ADAPTER

GABMF Male NPT to larger female NPT

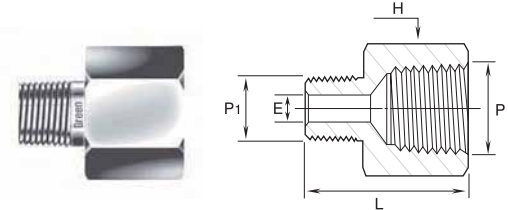

Part Number	P1 Male NPT in.	P Female NPT in.	L mm	E mm	H Hex mm
GABMF 2-4N	1/8	1/4	31.5	4.8	19.05
GABMF 2-6N	1/8	3/8	33.5	4.8	22.2
GABMF 4-6N	1/4	3/8	37.8	7.1	22.2
GABMF 2-8N	1/8	1/2	40.0	4.8	26.9
GABMF 4-8N	1/4	1/2	44.5	7.1	26.9
GABMF 6-8N	3/8	1/2	44.5	9.6	26.9
GABMF 4-12N	1/4	3/4	45.7	7.1	33.3
GABMF 6-12N	3/8	3/4	45.7	9.6	33.3
GABMF 8-12N	1/2	3/4	51.1	11.9	33.3
GABMF 4-16N	1/4	1	50.8	7.1	41.2
GABMF 8-16N	1/2	1	54.9	11.9	41.2
GABMF 12-16N	3/4	1	55.1	15.7	41.2

ADAPTER

GACMF Male ISO tapered to Female NPT

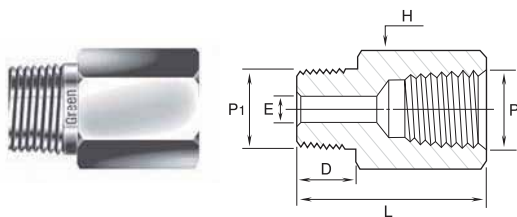

Part Number	P NPT in.	P1 ISO Thread Size	L mm	D mm	E mm	H Hex mm
GACMF-2RN	1/8	1/8-28 (7-1)	27.4	9.7	4.8	14.2
GACMF-4RN	1/4	1/4-19 (7-1)	35.8	14.2	7.1	19.05
GACMF-6RN	3/8	3/8-19 (7-1)	37.6	14.2	9.7	22.2
GACMF-8RN	1/2	1/2-14 (7-1)	49.0	19.1	11.9	26.9
GACMF-12RN	3/4	3/4-14 (7-1)	50.3	19.1	15.7	33.3
GACMF-16RN	1	1-11 (7-1)	58.0	23.9	22.3	41.2

ADAPTER

GADMF Male ISO parallel to female NPT

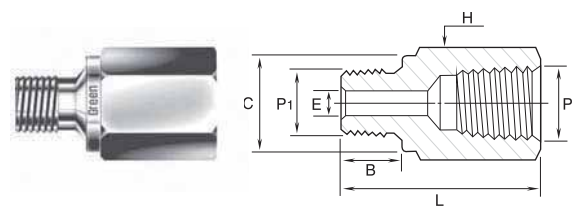

Part Number	P NPT in.	P1 ISO Thread Size	L mm	B mm	C mm	E mm	H Hex mm
GADMF-2GN	1/8	1/8-28 (228-1)	24.9	7.1	13.7	4.1	14.2
GADMF-4GN	1/4	1/4-19 (228-1)	33.3	11.2	17.8	5.8	19.05
GADMF-6GN	3/8	3/8-19 (228-1)	37.8	11.2	21.8	7.9	22.2
GADMF-8GN	1/2	1/2-14 (228-1)	43.9	14.2	26.1	11.9	26.9
GADMF-12GN	3/4	3/4-14 (228-1)	50.8	15.7	31.5	15.7	33.3
GADMF-16GN	1	1-11 (228-1)	53.1	18.3	38.9	19.8	41.2

REDUCING HEX BUSHING

GHB Male NPT to reduced female NPT

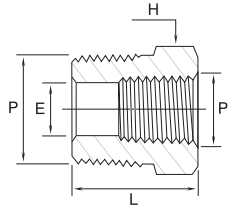

Part Number	P Male NPT in.	P1 Female NPT in.	L mm	E mm	H Hex mm	Working Pressure bar (psig)	
						SS316,C.Steel	Brass
GHB 4- 2N	1/4	1/8	26.7	7.1	14.2	447 (6400)	227 (3200)
GHB 6- 2N	3/8	1/8	21.8	8.5	17.4	633 (9100)	323 (4600)
GHB 6- 4N	3/8	1/4	30.0	9.6	19.05	454 (6500)	227 (3200)
GHB 8- 2N	1/2	1/8	27.4	8.5	22.2	840 (12100)	427 (6100)
GHB 8- 4N	1/2	1/4	27.4	11.7	22.2	571 (8200)	303 (4300)
GHB 8- 6N	1/2	3/8	35.6	11.9	22.2	365 (5200)	179 (2500)
GHB12- 4N	3/4	1/4	27.4	11.4	26.9	826 (11900)	413 (5900)
GHB12- 6N	3/4	3/8	27.4	15.0	26.9	564 (8100)	296 (4200)
GHB12- 8N	3/4	1/2	41.4	15.7	26.9	337 (4800)	165 (2300)
GHB16- 4N	1	1/4	34.8	11.4	34.9	999 (14400)	509 (7300)
GHB16- 8N	1	1/2	34.8	18.5	34.9	592 (8500)	296 (4200)
GHB16-12N	1	3/4	34.8	22.4	34.9	365 (5200)	179 (2500)

PIPE CAP

GC Female NPT

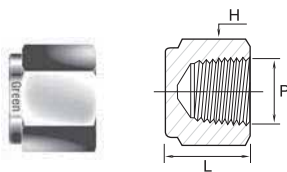

Part Number	P NPT in.	L mm	H Hex mm
GC- 2N	1/8	19.1	14.2
GC- 4N	1/4	22.9	19.05
GC- 6N	3/8	26.2	22.2
GC- 8N	1/2	34.0	26.9
GC-12N	3/4	36.6	33.3
GC-16N	1	41.1	41.2

PIPE PLUG

GP Male NPT

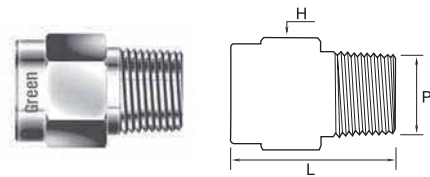

Part Number	P NPT in.	L mm	H Hex mm
GP- 2N	1/8	19.05	11.1
GP- 4N	1/4	24.1	14.2
GP- 6N	3/8	25	17.4
GP- 8N	1/2	30.5	22.2
GP-12N	3/4	30.5	26.9
GP-16N	1	38.1	34.9

Thread Fittings - Standard Rating

HEX COUPLING

GCG Female NPT both ends

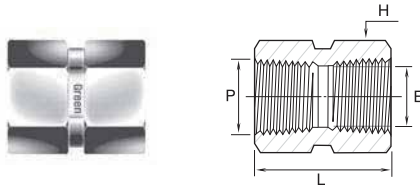

Part Number	P NPT in.	L mm	E mm	H Hex mm
GCG-2N	1/8	20.57	8.9	14.2
GCG-4N	1/4	30.22	10.87	19.05
GCG-6N	3/8	33.27	15.0	22.2
GCG-8N	1/2	39.62	18.7	26.9
GCG-12N	3/4	41.14	23.5	33.3
GCG-16N	1	50.8	29.7	41.2

HEX REDUCING COUPLING

GCGR Female NPT to reduced female NPT

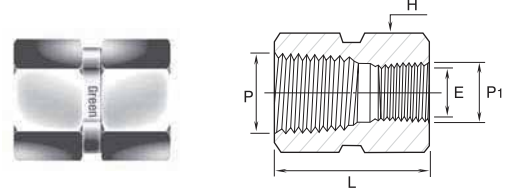

Part Number	P NPT in.	P1 Reduced NPT in.	L mm	E mm	H Hex mm
GCGR 4- 2N	1/4	1/8	31.2	8.9	19.05
GCGR 6- 4N	3/8	1/4	34.8	11.7	22.2
GCGR 8- 2N	1/2	1/8	39.4	8.7	26.9
GCGR 8- 4N	1/2	1/4	44.2	11.7	26.9
GCGR 8- 6N	1/2	3/8	45.0	15.0	26.9
GCGR 12- 4N	3/4	1/4	45.7	11.7	33.3
GCGR 16-12N	1	3/4	57.0	23.5	41.2

UNION BALL JOINT

GJU Female NPT both ends

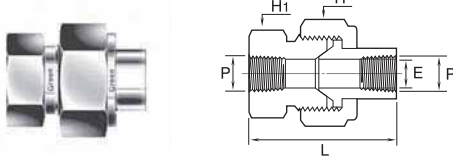

Part Number	P NPT in.	L mm	E mm	H Hex mm	H1 Wrench Flat mm
GJU-2N	1/8	45.7	6.9	28.6	23.8
GJU-4N	1/4	59.4	9.1	34.9	30.2
GJU-6N	3/8	63.5	13.2	38.1	33.3
GJU-8N	1/2	68.6	15.7	44.5	41.3
GJU-12N	3/4	79.2	22.4	50.8	47.6
GJU-16N	1	90.4	26.2	63.5	60.3

ISO PARALLEL COPPER GASKET

DGC For ISO Parallel male thread

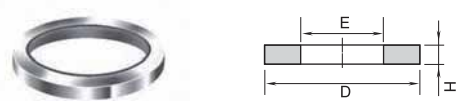

Part Number	ISO 228-1	E mm	H mm	D mm
DGC-2	1/8	9.9	1.0	15.0
DGC-4	1/4	13.2	1.5	19.1
DGC-6	3/8	16.8	1.5	23.1
DGC-8	1/2	21.1	1.5	26.9
DGC-12	3/4	26.7	2.0	33.0
DGC-16	1	33.3	2.0	40.1

HOLLOW HEX PLUG

GPA Male SAE/MS Straight Thread

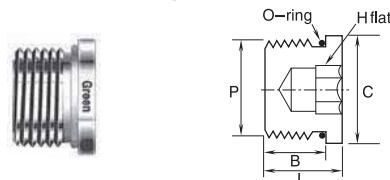

Part Number	P SAE/MS Thread	L mm	B mm	C mm	H mm	Uniform O-ring Size
GPA-4U	7/16-20	11.4	9.1	14.2	4.76	-904
GPA-6U	9/16-18	12.2	9.9	17.5	6.35	-906
GPA-8U	3/4-16	14.2	11.2	22.4	7.93	-908
GPA-12U	1 1/16-12	19.1	15.0	31.8	14.28	-912
GPA-16U	1 5/16-12	19.1	15.0	38.1	15.87	-916

HOLLOW HEX PLUG

GPB Male NPT

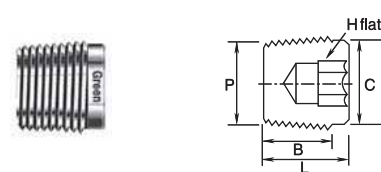

Part Number	P NPT in.	L mm	B mm	C mm	H mm
GPB-2N	1/8	10.4	7.4	9.4	4.76
GPB-4N	1/4	15.5	12.4	12.1	6.35
GPB-6N	3/8	15.0	11.9	15.7	7.93
GPB-8N	1/2	19.3	16.2	19.3	9.52

SNUBBER FITTING GS

Snubber fitting consists of fitting and sintered SS316 element. This protects pressure gauge or instruments from system pressure surge and shock. The sintered element damps (snubs) the line pressure shock but it eventually allows the gauge to readout the line pressure, reducing the gauge's response time.

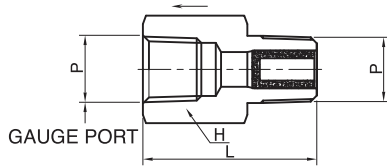

Part Number	P NPT in.	L mm	H mm	Working Pressure at 20°C (70°F) bar(psig)	
				SS316	Brass
GS-MF-4N-05*	1/4	35.6	3/4	303 (4400)	151 (2200)
GS-MF-8N-05*	1/2	49.3	1 1/16	337 (4900)	165 (2400)

Element Designator*	Pore Size Range, μm	Element Porosity	Cv
05	0.5 - 2	17%	0.046
2	1 - 4	22%	0.056
7	5 - 10	27%	0.12
15	11 - 25	36%	0.13
60	50 - 75	44%	0.38
90	75 - 110	45%	0.50

ELBOW

GL Female NPT both ends

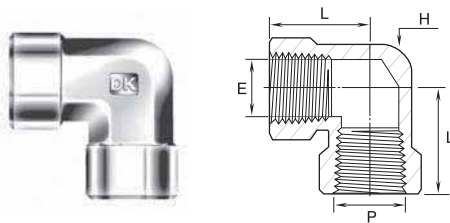

Part Number	P NPT in.	L mm	E mm	H Wrench Flat mm	Pressure Rating psi (bar)	
					SS316, C.Steel	Brass
GL- 2N	1/8	24.1	8.9	12.7	6200 (427)	3100 (213)
GL- 4N	1/4	29.0	11.7	17.5	7200 (496)	3600 (248)
GL- 6N	3/8	34.5	15.0	20.6	5600 (385)	2800 (192)
GL- 8N	1/2	37.0	18.7	25.4	5600 (385)	2800 (192)
GL-12N	3/4	46.5	23.5	31.8	5100 (351)	2500 (172)
GL-16N	1	48.8	29.7	42.9	6400 (440)	3200 (220)

STREET ELBOW

GLS Female to male NPT

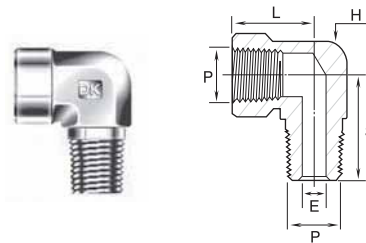

Part Number	P NPT in.	L mm	S mm	E mm	H Wrench Flat mm	Pressure Rating psi (bar)	
						SS316, C.Steel	Brass
GLS- 2N	1/8	24.1	19.6	4.8	12.7	6200 (427)	3100 (213)
GLS- 4N	1/4	29.0	26.5	7.1	17.5	7200 (496)	3600 (248)
GLS- 6N	3/8	34.5	28.2	9.6	20.6	5600 (385)	2800 (192)
GLS- 8N	1/2	37.0	35.3	11.9	25.4	5600 (385)	2800 (192)
GLS-12N	3/4	46.5	39.6	15.7	31.8	5100 (351)	2500 (172)
GLS-16N	1	48.8	49.2	22.3	42.9	5300 (365)	2600 (179)

Thread Fittings - Standard Rating

REDUCING STREET ELBOW

GLSR Female to reduced Male NPT

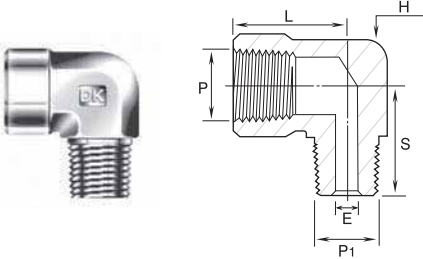

Part Number	P NPT in.	P1 Male NPT in.	L mm	S mm	E mm	H Wrench Flat mm	Pressure Rating psi (bar)	
							SS316, C.Steel	Brass
GLSR 4-2N	1/4	1/8	29.0	22.4	4.8	17.5	7200 (496)	3600 (248)
GLSR 6-4N	3/8	1/4	34.5	28.2	7.1	20.6	5600 (385)	2800 (192)
GLSR 8-4N	1/2	1/4	37.0	30.5	7.1	25.4	5600 (385)	2800 (192)
GLSR 8-6N	1/2	3/8	37.0	30.5	9.6	25.4	5600 (385)	2800 (192)
GLSR12-8N	3/4	1/2	46.5	41.6	11.9	31.8	5100 (351)	2500 (172)
GLSR16-8N	1	1/2	48.8	45.5	11.9	42.9	5300 (365)	2600 (179)

MALE ELBOW

GLM Male NPT both ends

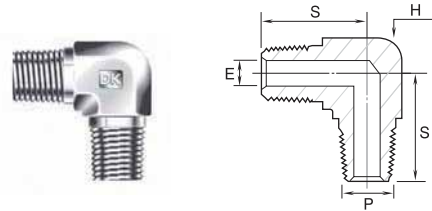

Part Number	P NPT in.	S mm	E mm	H Wrench Flat mm	Pressure Rating psi (bar)	
					SS316, C.Steel	Brass
GLM - 2N	1/8	19.05	4.8	12.7	10000 (689)	5000 (344)
GLM - 4N	1/4	24.5	7.1	12.7	8000 (551)	4000 (275)
GLM - 6N	3/8	26.9	9.6	17.5	7800 (537)	3900 (268)
GLM - 8N	1/2	33.2	11.9	20.6	7700 (530)	3800 (261)
GLM - 12N	3/4	35.3	15.7	25.4	7300 (502)	3600 (248)
GLM - 16N	1	44.5	22.3	31.8	5300 (365)	2600 (179)

TEE

GT Female NPT

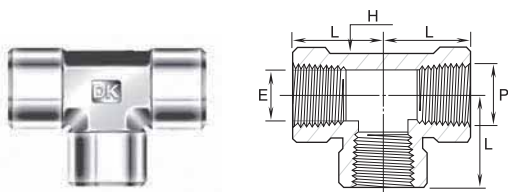

Part Number	P NPT in.	L mm	E mm	H Wrench Flat mm	Pressure Rating psi (bar)	
					SS316, C.Steel	Brass
GT- 2N	1/8	24.1	8.9	12.7	6200 (437)	3100 (213)
GT- 4N	1/4	29.0	11.7	17.5	7200 (496)	3600 (248)
GT- 6N	3/8	34.5	15.0	20.6	5600 (385)	2800 (192)
GT- 8N	1/2	37.0	18.7	25.4	5600 (385)	2800 (192)
GT-12N	3/4	46.5	23.5	31.8	5100 (351)	2500 (172)
GT-16N	1	48.8	29.7	42.9	6400 (440)	3200 (220)

RUN TEE

GTR Female to male to female NPT

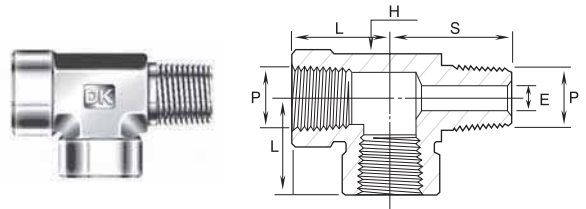

Part Number	P NPT in.	L mm	S mm	E mm	H Wrench Flat mm	Pressure Rating psi (bar)	
						SS316, C.Steel	Brass
GTR- 2N	1/8	24.1	19.6	4.8	12.7	6200 (427)	3100 (213)
GTR- 4N	1/4	29.0	26.5	7.1	17.5	7200 (496)	3600 (248)
GTR- 6N	3/8	34.5	28.2	9.6	20.6	5600 (385)	2800 (192)
GTR- 8N	1/2	37.0	35.3	11.9	25.4	5600 (385)	2800 (192)
GTR-12N	3/4	46.5	39.6	15.7	31.8	5100 (351)	2500 (172)
GTR-16N	1	48.8	49.2	22.3	42.9	5300 (365)	2600 (179)

BRANCH TEE

GTB Female to female to male NPT

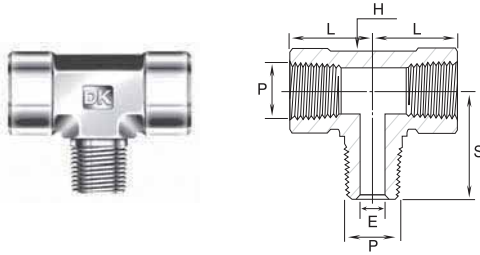

Part Number	P NPT in.	L mm	S mm	E mm	H Wrench Flat mm	Pressure Ratings, psig(bar)	
						SS316, C.Steel	Brass
GTB- 2N	1/8	24.1	19.6	4.8	12.7	6200 (427)	3100 (213)
GTB- 4N	1/4	29.0	26.5	7.1	17.5	7200 (496)	3600 (248)
GTB- 6N	3/8	34.5	28.2	9.6	20.6	5600 (385)	2800 (192)
GTB- 8N	1/2	37.0	35.3	11.9	25.4	5600 (385)	2800 (192)
GTB-12N	3/4	46.5	39.6	15.7	31.8	5100 (351)	2500 (172)
GTB-16N	1	48.8	49.2	22.3	42.9	5300 (365)	2600 (179)

MALE TEE

GTM Male NPT

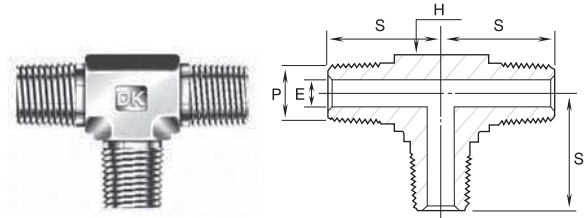

Part Number	P NPT in.	S mm	E mm	H Wrench Flat mm	Pressure Ratings, psig(bar)	
					SS316, C.Steel	Brass
GTM- 2N	1/8	19.05	4.8	12.7	10000 (689)	5000 (344)
GTM- 4N	1/4	24.5	7.1	12.7	8000 (551)	4000 (275)
GTM- 6N	3/8	26.9	9.6	17.5	7800 (537)	3900 (268)
GTM- 8N	1/2	33.2	11.9	20.6	7700 (530)	3800 (261)
GTM-12N	3/4	35.3	15.7	25.4	7300 (502)	3600 (248)
GTM-16N	1	44.5	22.3	31.8	5300 (365)	2600 (179)

CROSS

GX Female NPT

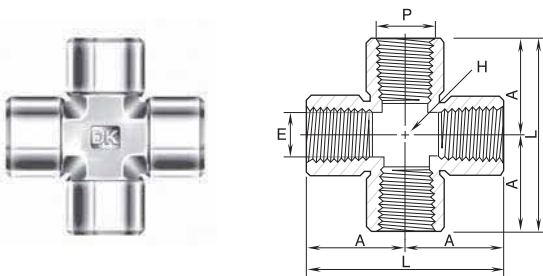

Part Number	P NPT in.	L mm	E mm	H Wrench Flat mm	Pressure Ratings, psig(bar)	
					SS316, C.Steel	Brass
GX- 2N	1/8	48.2	8.6	12.7	6200 (427)	3100 (213)
GX- 4N	1/4	58.0	11.4	17.5	7200 (496)	3600 (248)
GX- 6N	3/8	69.0	15.0	20.6	5600 (385)	2800 (192)
GX- 8N	1/2	74.0	18.5	25.4	5600 (385)	2800 (192)
GX-12N	3/4	93.0	23.9	31.8	5100 (351)	2500 (172)
GX-16N	1	97.6	29.7	42.9	5300 (365)	2600 (179)

10K Thread Fittings

Pressure Rating : 10,000 psi (690 bar)



DK-Lok 10K Thread Fittings are especially designed to assure safe service in the high pressure application of 10 000psig.

The 10,000 psig working pressure satisfy the design requirements of ASME B31.3 Processing Pipe Code.

Features

- The fittings are available in 1/8" through 1" pipe threads.
- The Male Pipe Threads are precisely rolled for a high pressure application.
- Fittings are available only in stainless steel material. Therefore the part numbers of these fittings include the material designator -S.

Table 5. **Material Standards**

Material	Form	Standards
Stainless Steel 316	Bar Stock	ASTM A276 Type 316 / ASTM A479 Type 316
	Forging	ASTM A182 F316

ELBOW

GL-10K Female NPT both ends

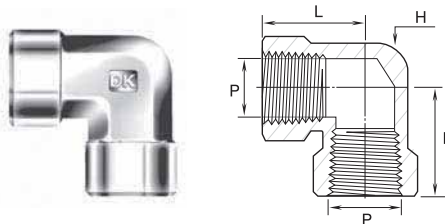

Part Number	P NPT in.	H Wrench flat in.(mm)	L mm
GL-2N-10K-S	1/8	13/16(20.65)	26.0
GL-4N-10K-S	1/4	1(25.4)	37.0
GL-6N-10K-S	3/8	1-1/4(31.75)	46.5
GL-8N-10K-S	1/2	1-11/16(42.86)	50.0
GL-12N-10K-S	3/4	50	57.0
GL-16N-10K-S	1	55	57.0

TEE

GT-10K Female NPT

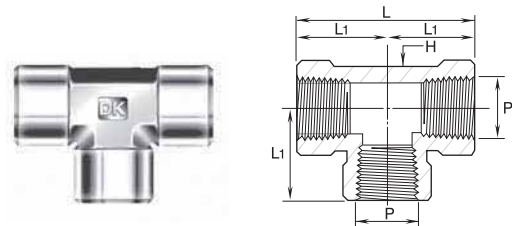

Part Number	P NPT in.	H Wrench flat in.(mm)	L mm	L1 mm
GT-2N-10K-S	1/8	13/16(20.65)	52	26
GT-4N-10K-S	1/4	1(25.4)	74	37
GT-6N-10K-S	3/8	1-1/4(31.75)	93	46.5
GT-8N-10K-S	1/2	1-11/16(42.86)	100	50
GT-12N-10K-S	3/4	50	114	57
GT-16N-10K-S	1	55	114	57

CROSS

GX-10K Female NPT both ends

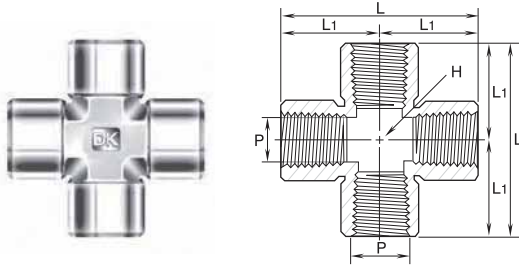

Part Number	P NPT in.	H Wrench flat in.(mm)	L mm	L1 mm
GX-2N-10K-S	1/8	13/16 (20.65)	52	26
GX-4N-10K-S	1/4	1 (25.4)	74	37
GX-6N-10K-S	3/8	1-1/4 (31.75)	93	46.5
GX-8N-10K-S	1/2	1-11/16 (42.86)	100	50
GX-12N-10K-S	3/4	50	114	57
GX-16N-10K-S	1	55	114	57

HEX NIPPLE

GNH-10K Male NPT both ends

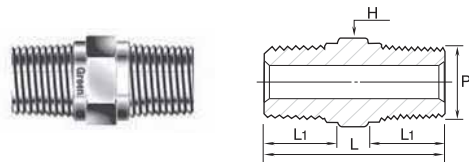

Part Number	P NPT in.	H HEX in.(mm)	L mm	L1 mm
GNH-2N-10K-S	1/8	7/16 (11.11)	25.6	7.4
GNH-4N-10K-S	1/4	9/16 (14.28)	35.5	14.2
GNH-6N-10K-S	3/8	11/16 (17.46)	36.3	19.1
GNH-8N-10K-S	1/2	7/8 (22.2)	46.7	19.1
GNH-12N-10K-S	3/4	1-1/16 (26.98)	46.7	19.1
GNH-16N-10K-S	1	1-3/8 (34.92)	58.9	23.9

HEX COUPLING

GCG-10K Female NPT both ends

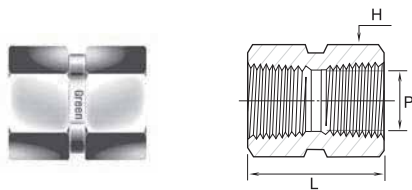

Part Number	P NPT in.	H HEX in.(mm)	L mm
GCG-2N-10K-S	1/8	13/16 (20.65)	20.5
GCG-4N-10K-S	1/4	1 (25.4)	30.2
GCG-6N-10K-S	3/8	1-1/4 (31.75)	33.2
GCG-8N-10K-S	1/2	1-1/2 (38.1)	39.6
GCG-12N-10K-S	3/4	1-3/4 (44.4)	41.1
GCG-16N-10K-S	1	2-1/8 (53.9)	50.8

ADAPTER

GAAMF-10K Female NPT to male NPT

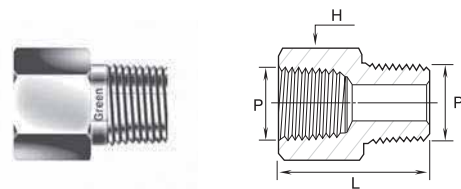

Part Number	P NPT in.	H HEX in.(mm)	L mm
GAAMF-2N-10K-S	1/8	13/16 (20.65)	27.9
GAAMF-4N-10K-S	1/4	1 (25.4)	36.7
GAAMF-6N-10K-S	3/8	1-1/4 (31.75)	38.5
GAAMF-8N-10K-S	1/2	1-1/2 (38.1)	51.3
GAAMF-12N-10K-S	3/4	1-3/4 (44.4)	52.1
GAAMF-16N-10K-S	1	2-1/8 (53.9)	58.7

REDUCING ADAPTER

GABMF-10K Male NPT to larger female NPT

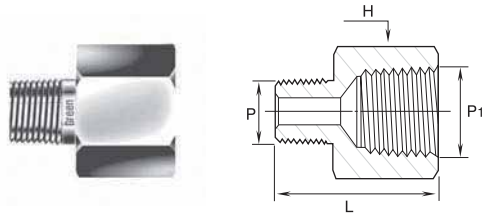

Part Number	P NPT in.	P1 NPT in.	H HEX in.(mm)	L mm
GABMF2-4N-10K-S	1/8	1/4	1 (25.4)	32.2
GABMF4-6N-10K-S	1/4	3/8	1-1/4 (31.75)	38.5
GABMF4-8N-10K-S	1/4	1/2	1-1/2 (38.1)	46.4
GABMF4-12N-10K-S	1/4	3/4	1-3/4 (44.4)	47.2
GABMF6-8N-10K-S	3/8	1/2	1-1/2 (38.1)	46
GABMF6-12N-10K-S	3/8	3/4	1-3/4 (44.4)	47.2
GABMF6-16N-10K-S	3/8	1	2-1/8 (53.9)	49
GABMF8-12N-10K-S	1/2	3/4	1-3/4 (44.4)	52.1
GABMF8-16N-10K-S	1/2	1	2-1/8 (53.9)	53.9
GABMF12-16N-10K-S	3/4	1	2-1/8 (53.9)	53.9

REDUCING ADAPTER

GAMF-10K Male NPT to reduced female NPT

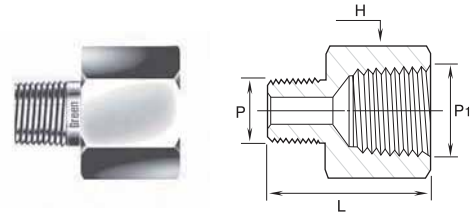

Part Number	P NPT in.	P1 NPT in.	H HEX in.(mm)	L mm
GAMF4-2N-10K-S	1/4	1/8	13/16 (20.65)	32.4
GAMF6-2N-10K-S	3/8	1/8	13/16 (20.65)	32.4
GAMF6-4N-10K-S	3/8	1/4	1 (25.4)	36.3
GAMF8-2N-10K-S	1/2	1/8	7/8 (22.2)	37.3
GAMF8-4N-10K-S	1/2	1/4	1 (25.4)	41.2
GAMF8-6N-10K-S	1/2	3/8	1-1/4 (31.75)	43.4
GAMF12-4N-10K-S	3/4	1/4	1-1/16 (26.98)	41.6
GAMF12-6N-10K-S	3/4	3/8	1-1/4 (31.75)	43.4
GAMF12-8N-10K-S	3/4	1/2	1-1/2 (38.1)	51.3
GAMF16-4N-10K-S	1	1/4	1-3/8 (34.92)	46.4
GAMF16-8N-10K-S	1	1/2	1-1/2 (38.1)	55.7
GAMF16-12N-10K-S	1	3/4	1-3/4 (44.4)	56.9

Thread Fittings for Over 1"

Pressure Rating : 6,000 psi (413 bar)

DK-Lok 6K Thread Fittings are developed especially for over 1" piping system where 6,000 psig pressure rating is required. The 6,000 psig fittings are designed and rated specifically for 6,000 psi working pressure meeting the requirements of ASME B31.3 Processing Pipe Code.

Features

- The fittings are available in 1 1/4", 1 1/2" and 2" pipe threads.
- Fittings are available only in stainless steel material. Therefore the part numbers of these fittings include the material designator -S.

ELBOW

GL-6K Female NPT both ends

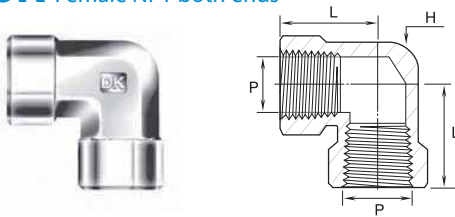

Part Number	Working Pressure	P NPT in.	H Wrench flat in.(mm)	L mm
GL-20N-6K-S	6,000 psi 413 bar	1-1/4	2-3/4 (69.85)	70
GL-24N-6K-S	6,000 psi 413 bar	1-1/2	2-3/4 (69.85)	70
GL-32N-6K-S	6,000 psi 413 bar	2	3 (76.2)	70

TEE

GT-6K Female NPT

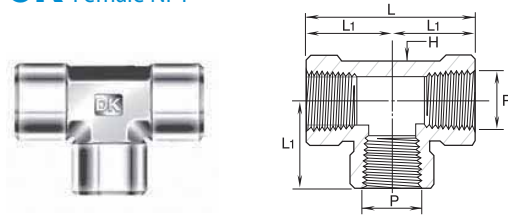

Part Number	Working Pressure	P NPT in.	H Wrench flat in.(mm)	L mm	L1 mm
GT-20N-6K-S	6,000 psi 413 bar	1-1/4	2-3/4 (69.85)	140	70
GT-24N-6K-S	6,000 psi 413 bar	1-1/2	2-3/4 (69.85)	140	70
GT-32N-6K-S	6,000 psi 413 bar	2	3 (76.2)	140	70

HEX COUPLING

GCG-6K Female NPT both ends

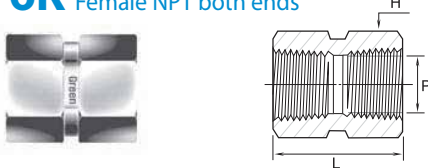

Part Number	Working Pressure	P NPT in.	H HEX in.(mm)	L mm
GCG-20N-6K-S	6,000 psi 413 bar	1-1/4	2-1/8 (53.9)	66.55
GCG-24N-6K-S	6,000 psi 413 bar	1-1/2	2-3/8 (60.32)	66.55
GCG-32N-6K-S	6,000 psi 413 bar	2	3 (76.2)	66.55

HEX NIPPLE

GNH-6K Male NPT both ends

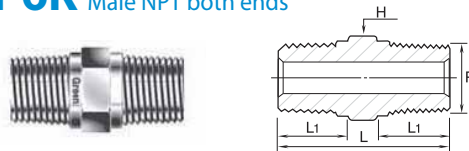

Part Number	Working Pressure	P NPT in.	H HEX in.(mm)	L mm	L1 mm
GNH-20N-6K-S	6,000 psi 413 bar	1-1/4	1-3/4 (44.45)	61.21	23.9
GNH-24N-6K-S	6,000 psi 413 bar	1-1/2	2 (50.8)	68	26.2
GNH-32N-6K-S	6,000 psi 413 bar	2	2-3/4 (69.85)	69.8	26.9

CROSS

GX-6K Female NPT

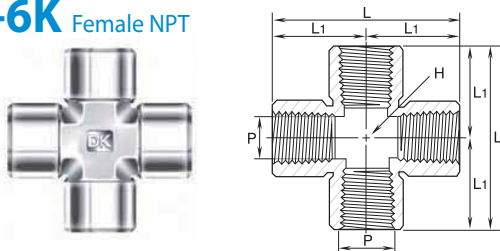

Part Number	Working Pressure	P NPT in.	H HEX in.(mm)	L mm	L1 mm
GX-20N-6K-S	6,000 psi 413 bar	1-1/4	2-3/4 (69.85)	140	70
GX-24N-6K-S	6,000 psi 413 bar	1-1/2	2-3/4 (69.85)	140	70
GX-32N-6K-S	6,000 psi 413 bar	2	3 (76.2)	140	70

Weld Fittings

DK-Lok weld fittings are designed to provide permanent weld connections in pressure impulse, system vibration, and temperature cycling. Tube socket end design meets and exceeds the requirements of ASME B16.11 for ease of tube socket welding.

Features

- DK-Lok weld tube socket ports have a tapered sizing angle at the end that holds tubing properly and provides approx. 1.5mm(0.08") welding gap as specified in ASME B16.11. This feature allows consistent welding assembly as well as pre-assembly of many tubing runs before welding.
- Fittings are available in stainless steel only. Thus the part number of table below contains the material designator-S.

Tube socket weld fitting

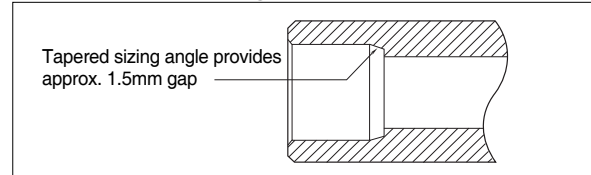

Technical information

Use like tubing and fitting material. This ensure the same coefficient of expansion & reduction in the thermal cycle and the same corrosion resistance.

Standard fitting material is Stainless steel ASTM A276 type 316 of bar stock and ASTM A182 F316 of forging.

Pressure ratings shown in the dimensional tables are calculated in accordance with the requirements of ASME B31.3

UNION

GUSW Tube to Tube

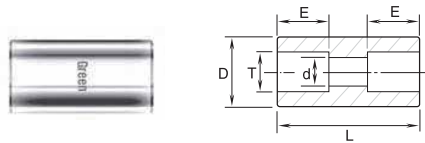

Part Number	T Tube OD	d mm	D mm	E mm	L mm	Working psig	Pressure bar
GUSW-4T-S	1/4	4.6	13.0	7.1	19.0	10,000	689
GUSW-6T-S	3/8	7.1	15.8	7.9	22.4	7,600	523
GUSW-8T-S	1/2	10.2	19.0	9.7	26.9	6,200	427
GUSW-10T-S	5/8	12.7	24.0	10.4	30.2	6,400	440
GUSW-12T-S	3/4	15.7	26.9	11.2	33.3	5,500	378
GUSW-16T-S	1	22.1	35.0	15.7	36.6	5,200	358

UNION ELBOW

GLSW Tube to Tube

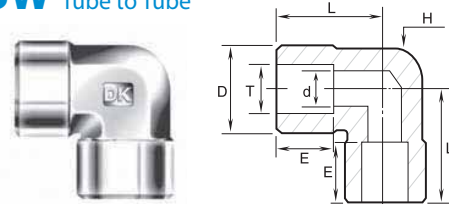

Part Number	T Tube OD	d mm	D mm	E mm	H Wrench Flat mm	L mm	Working psig	Pressure bar
GLSW-4T-S	1/4	4.6	13.4	7.1	12.7	21.8	11,300	778
GLSW-6T-S	3/8	7.1	15.8	7.9	12.7	24.5	8,400	578
GLSW-8T-S	1/2	10.2	20.6	9.7	17.4	29.0	7,800	537
GLSW-10T-S	5/8	12.7	23.8	10.4	20.6	34.5	6,700	461
GLSW-12T-S	3/4	15.7	28.6	11.2	25.4	37.0	6,700	461
GLSW-16T-S	1	22.1	35.0	15.7	31.8	46.5	5,800	400

UNION TEE

GTSW Tubes

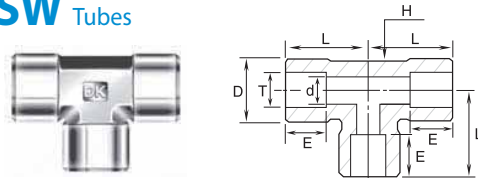

Part Number	T Tube OD	d mm	D mm	E mm	H Wrench Flat mm	L mm	Working psig	Pressure bar
GTSW-2T-S	1/8	2.3	13.4	2.5	12.7	15.0	11,800	813
GTSW-4T-S	1/4	4.6	13.4	7.1	12.7	21.8	11,300	778
GTSW-6T-S	3/8	7.1	15.8	7.9	12.7	24.0	8,400	578
GTSW-8T-S	1/2	10.2	20.6	9.7	17.4	29.0	7,800	537
GTSW-10T-S	5/8	12.7	23.8	10.4	20.6	34.5	6,700	461
GTSW-12T-S	3/4	15.7	28.6	11.2	25.4	37.0	6,700	461
GTSW-16T-S	1	22.1	35.0	15.7	31.8	46.5	5,800	400

MALE CONNECTOR

GCMSW

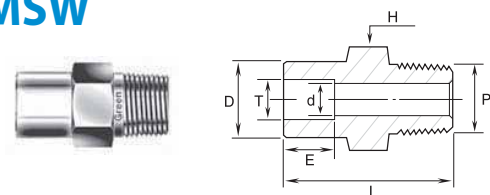

Part Number	T Tube OD	P NPT in.	d mm	D mm	E mm	H Hex mm	L mm	Working psig	Pressure bar
GCMSW4T-4N-S	1/4	1/4	4.6	12.2	7.1	14.2	29.2	7,500	516
GCMSW6T-4N-S	3/8	1/4	7.1	15.3	7.9	15.8	31.8	7,500	516
GCMSW6T-6N-S	3/8	3/8	7.1	15.3	7.9	17.4	31.8	7,300	502
GCMSW6T-8N-S	3/8	1/2	7.1	15.3	7.9	22.2	37.8	7,200	496
GCMSW8T-4N-S	1/2	1/4	7.1	18.5	9.7	19.05	33.3	6,200	427
GCMSW8T-6N-S	1/2	3/8	9.4	18.5	9.7	19.05	33.3	6,200	427
GCMSW8T-8N-S	1/2	1/2	10.2	18.5	9.7	22.2	38.9	6,200	427

FEMALE CONNECTOR

GCFSW Tube to female NPT

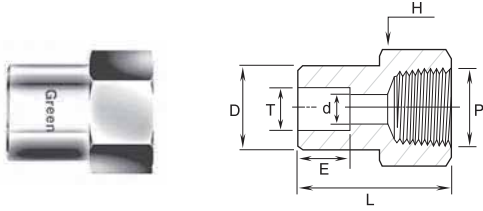

Part Number	T Tube OD	P-NPT	d mm	D mm	E mm	H Hex mm	L mm	Working psig	Pressure bar
GCFSW 2T-2N-S	1/8	1/8	2.3	7.4	2.5	14.2	21.1	6100	420
GCFSW 4T-2N-S	1/4	1/8	4.6	12.2	7.1	14.2	26.7	6100	420
GCFSW 4T-4N-S	1/4	1/4	4.6	12.2	7.1	19.05	30.0	6200	427
GCFSW 6T-4N-S	3/8	1/4	7.1	15.3	7.9	19.05	31.5	6200	427
GCFSW 8T-6N-S	1/2	3/8	10.2	18.5	9.7	22.2	34.5	5000	344
GCFSW 8T-8N-S	1/2	1/2	10.2	18.5	9.7	26.9	40.4	4600	316
GCFSW10T-8N-S	5/8	1/2	12.7	23.4	10.4	26.9	41.9	4600	316
GCFSW12T-12N-S	3/4	3/4	15.7	26.7	11.2	33.3	43.9	4300	296

MALE ELBOW

GLMSW Tube to male NPT

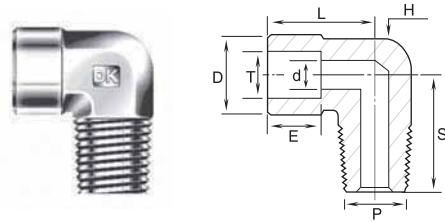

Part Number	T Tube OD	P-NPT	d mm	D mm	E mm	H Wrench Flat mm	L mm	S mm	Working psig	Pressure bar
GLMSW 4T-4N-S	1/4	1/4	4.6	15.8	7.1	12.7	20.1	24.5	7500	516
GLMSW 6T-4N-S	3/8	1/4	7.1	15.8	7.9	12.7	24.1	24.5	7500	516
GLMSW 6T-6N-S	3/8	3/8	7.1	20.6	7.9	17.4	24.6	29.0	7300	502
GLMSW 6T-8N-S	3/8	1/2	7.1	23.8	7.9	20.6	25.9	34.5	7200	496
GLMSW 8T-8N-S	1/2	1/2	10.2	23.8	9.7	20.6	27.4	34.5	6200	427
GLMSW12T-12N-S	3/4	3/4	15.7	28.6	11.2	25.4	37.0	37.0	6700	461

FEMALE ELBOW

GLFSW Tube to female NPT

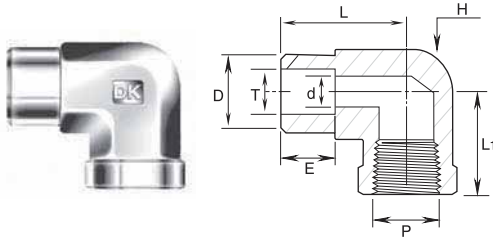

Part Number	T Tube OD	P-NPT	d mm	D mm	E mm	H Wrench Flat mm	L mm	L1 mm	Working Pressure	
									psig	bar
GLFSW4T-4N-S	1/4	1/4	4.6	12.2	7.1	17.4	22.9	29.7	6200	427
GLFSW6T-4N-S	3/8	1/4	7.1	15.3	7.9	17.4	25.1	29.7	7000	482
GLFSW6T-8N-S	3/8	1/2	7.1	15.3	7.9	25.4	28.7	37.0	5400	372
GLFSW8T-8N-S	1/2	1/2	10.2	18.5	9.7	25.4	30.2	37.0	5400	372

PIPE TO TUBE SOCKET WELD

GUWSW

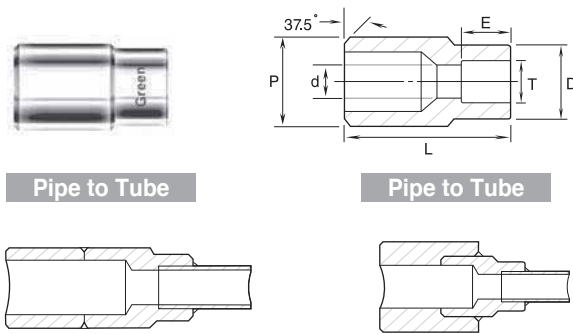

Part Number	P Pipe Size	T Tube Socket OD	d mm	D mm	E mm	L mm	Working Pressure	
							psig	bar
GUWSW4P-4T-S	1/4	1/4	4.6	13.7	7.1	22.4	9600	661
GUWSW6P-6T-S	3/8	3/8	7.1	15.3	7.9	26.2	7600	523
GUWSW6P-8T-S	3/8	1/2	10.2	18.5	9.7	27.9	6200	427
GUWSW8P-4T-S	1/2	1/4	4.6	12.2	7.1	28.4	7300	502
GUWSW8P-6T-S	1/2	3/8	7.1	15.3	7.9	28.4	7300	502
GUWSW8P-8T-S	1/2	1/2	10.2	18.5	9.7	30.2	6200	427
GUWSW12P-6T-S	3/4	3/8	7.1	15.3	7.9	38.1	6200	427
GUWSW12P-8T-S	3/4	1/2	10.2	18.5	9.7	38.1	6200	427

TUBE TO TUBE SOCKET WELD

GUTWSW

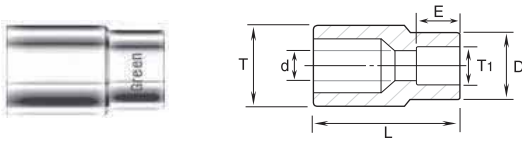

Tube to Tube

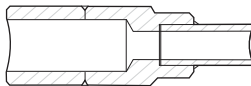

Part Number	T Tube O.D	T1 Tube Socket O.D	d mm	D mm	E mm	L mm	Working Pressure	
							psig	bar
GUTWSW 4T-2T-S	1/4	1/8	2.3	7.4	2.5	14.2	11800	813
GUTWSW 6T-4T-S	3/8	1/4	4.6	12.2	7.1	19.1	7700	530
GUTWSW 8T-4T-S	1/2	1/4	4.6	12.7	7.1	22.4	7000	482
GUTWSW 8T-6T-S	1/2	3/8	8.1	15.7	7.9	22.4	7000	482
GUTWSW 12T-8T-S	3/4	1/2	10.2	18.5	9.7	28.4	5900	406
GUTWSW 16T-8T-S	1	1/2	10.2	18.5	9.7	35.1	5600	386

NOTE

All dimensions are in millimeters unless otherwise specified and only for reference. All dimensions are subject to change. All dimensions are subject to change. All the dimensions shown in this catalog are not for design purpose, but for reference only and the accuracy of information here is not the liability of our company.



Safe Component Selection

The selection of component for any applications or system design must be considered to ensure safe performance. Component function, material compatibility, component ratings, proper installation, operation and maintenance remain the sole responsibility of the system designer and the user. DK-Lok accepts no liability for any improper selection, installation, operation or maintenance.